

Nordstrom Contracting
 Consulting Corp
 36 Theills Mt Ivy Rd
 Pomona, NY 10970

LETTER OF TRANSMITTAL

Project 561A4-18-102
 Lyons VA - Correct FCA
 Deficiencies Bld 1

02/01/2023

To: Mr. Gary Bohner

General Engineer
 Montrose Campus
 151 Knollcroft Rd
 Lyons, NJ 07939

Submittal # 14

We are sending you Herewith Delivered by Hand Under Separate Cover Via ELECTRONIC

Plans Prints Shop Dwgs Samples Specifications Other _____

Copies	Item	# Pages	Description
			Division 08- Openings- Stainless Steel Door & Frame
1	1	2	USA Fire Door- Product Order Sheet- Listing All Materials
1	2	1	Stainless Door- Door Frame- To be fully welded, masonry wall anchoring
1	3	1	Stainless Door- 1-3/4" Thick 18 GA / 304 Stainless # 4 Finish Door With optional top & bottom seal
1	4	1	Cal-Royal- Hinges
1	5	2	Stainless Door- Pierce & Dimple Anchor Bolts for Door Frame
1	6		
1	7		
1	8		
1	9		
1	10		

The Above Listed Items are transmitted as indicted below:

Return By Date: SEE BAR CHART

_____ Approved

_____ Approved with corrections as noted on submittal data and/or attached sheets (s)

Signature: _____

Title: _____

Date: _____

Remarks: _____



USA Fire Door, LLC
 101 W. Walnut St. #127
 Gardena, CA 90248

(844)321-3667
 www.usafiredoor.com
 sales@usafiredoor.com

Estimate / Order Confirmation

EST 46315

Issued:12/29/2022

Bill To
 Nordstrom Contracting & Consulting Corp.
 Michael Nordstrom
 36 Theills Mt. Ivy Road.
 Pomona, NY 10970
 USA

Ship To
 Nordstrom Contracting & Consulting Corp.
 Michael Nordstrom
 36 Theills Mt. Ivy Road.
 Pomona, NY 10970
 USA

P.O. # / Job Name	Rep Initial	Rep Name
	JA	Jason

Line #	Product Description	Qty
	#VERIFY HANDING	
	#ESTIMATE INCLUDES DOOR, FRAME AND HINGES ONLY	
	MF QT REF: _D48032 Date: _12/30/22	
1D	Custom Commercial Stainless Steel Door: Edge Seam (locks) Gauge/Material: _ 18 GA / 304 STAINLESS # 4 FINISH Core: _ POLYSTYRENE Size: _ 35-13/16" X 83-1/4" X-1-3/4" Fire Rating: _ NONE Hinge Prep: _345 Lock Prep: _161C Additional Specifications: _ Flush Top Cap / Handing: _	1
1F	Custom Commercial Stainless Steel Door Frame: Gauge/Material: _ 16 GA / 304 STAINLESS # 4 FINISH Frame Profile Type: _ UNEQUAL DOUBLE RABBET - WITH HOSPITAL STOPS Door Opening Size: _ 3/0 X 7/0 Overall Frame Depth: _ 5-3/4" Anchor Type(s): _ PIERCE AND DIMPLE WITH MASX BOLTS Hinge Prep: _345 Strike Prep: _ASA Fire Rating: _NONE Additional Specifications: _AMWELD/STEELCRAFT LOCATIONS, Welded Face Ground and Polished Handing: _ Commercial Door Handing: All Views from Outside. Qty: ___ Left Hand (Door Pushes In, Hinges are on the Left.) Qty: ___ Right Hand (Door Pushes In, Hinges are on the Right.) Qty: ___ Left Hand Reverse (Door Pulls Out, Hinges are on the Left.) Qty: ___ Right Hand Reverse (Door Pulls Out, Hinges are on the Right.) Outside Finished Frame Dimensions: 40" X 86" X 1-3/4" Nominal Door Width + 4" Nominal Door Height + 2"	1
2	CRP-BB31-US32D 4-1/2" x 4-1/2" Standard Weight, .134 Gauge, Two Ball Bearing, Full Mortise Type, Square Corner Hinge, US32D Satin Stainless Steel Base Material & Finish.	3

Please review carefully. USA Fire Door is not responsible for items that were ordered incorrectly.

BUYER INITIALS: _____

Frames

STANDARD MANUFACTURING CONSTRUCTION DETAILS

- Three Sided Frame
- 16, 14, 12 or 10 gauge Stainless Steel
- Alloy 304, 304L, 316, 316L
- Finish #4 Satin (*standard)
- Vertical Grain (*standard)
- Mitered Corners
- Face Fully Welded (*standard)

**See Options or Consult with Factory for Other Applications*

Snapshot



Vertical Grain - Standard

Snapshot



Grain long Direction Of Each Piece - Option

Snapshot



Face Weld

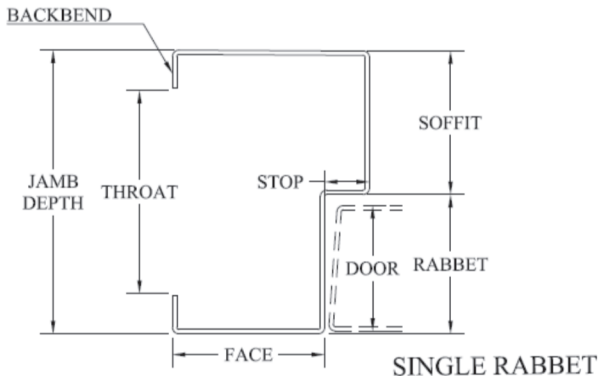
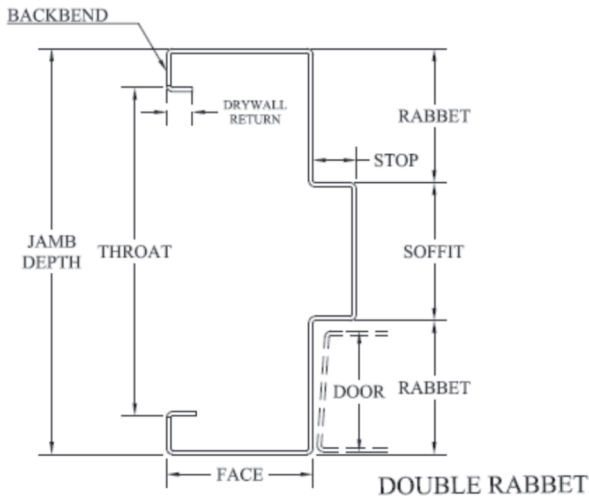

>>All specifications are subject to change without notice<<



Seamed Doors

STANDARD MANUFACTURING CONSTRUCTION DETAILS

- 1-3/4" Thick Door (*standard)
- 18 or 16 gauge Stainless Steel
- Alloy 304, 304L, 316, 316L
- Finish #4 Satin (*standard)
- Vertical Grain
- Edge Seam (lockseam)
- Polystyrene Core (*standard)
- Inverted Top and Bottom Channels: 18 gauge

**See Options or Consult with Factory for Other Applications*

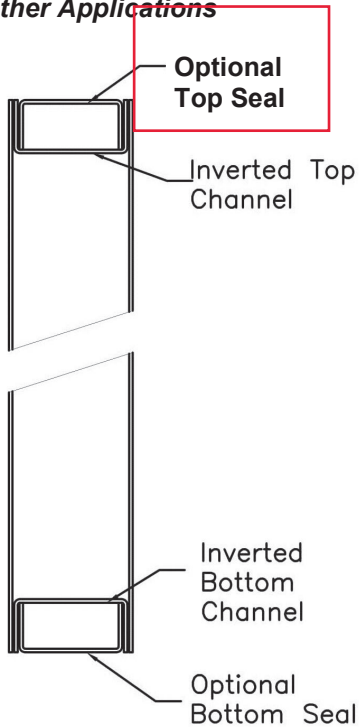
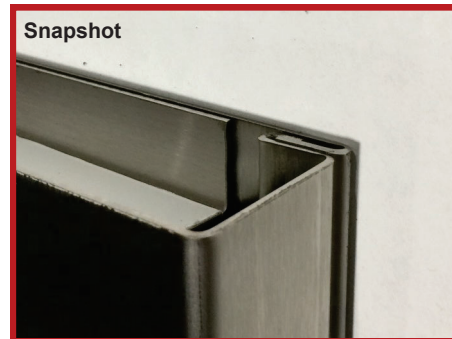

Top and Bottom Channels

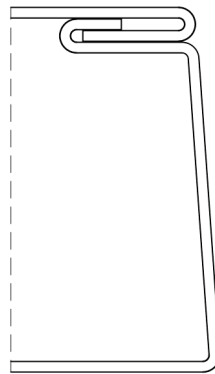

Continuous Interlocking Vertical Edge Seam

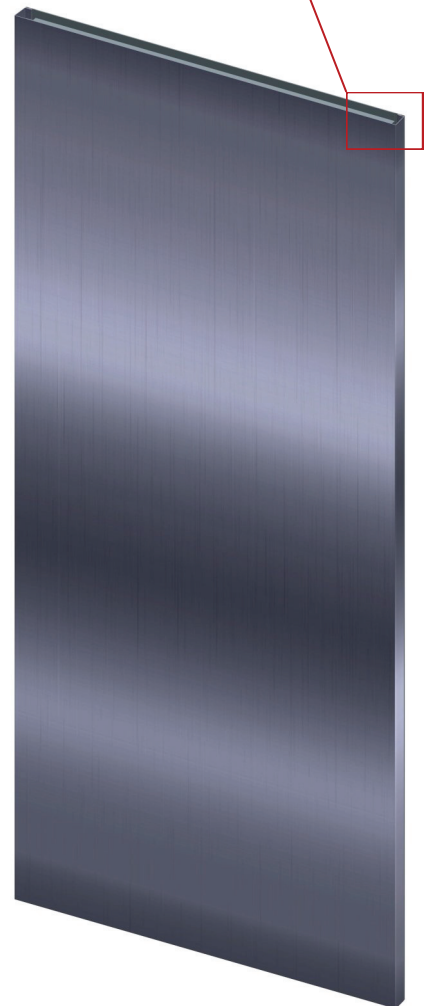

>>All specifications are subject to change without notice<<



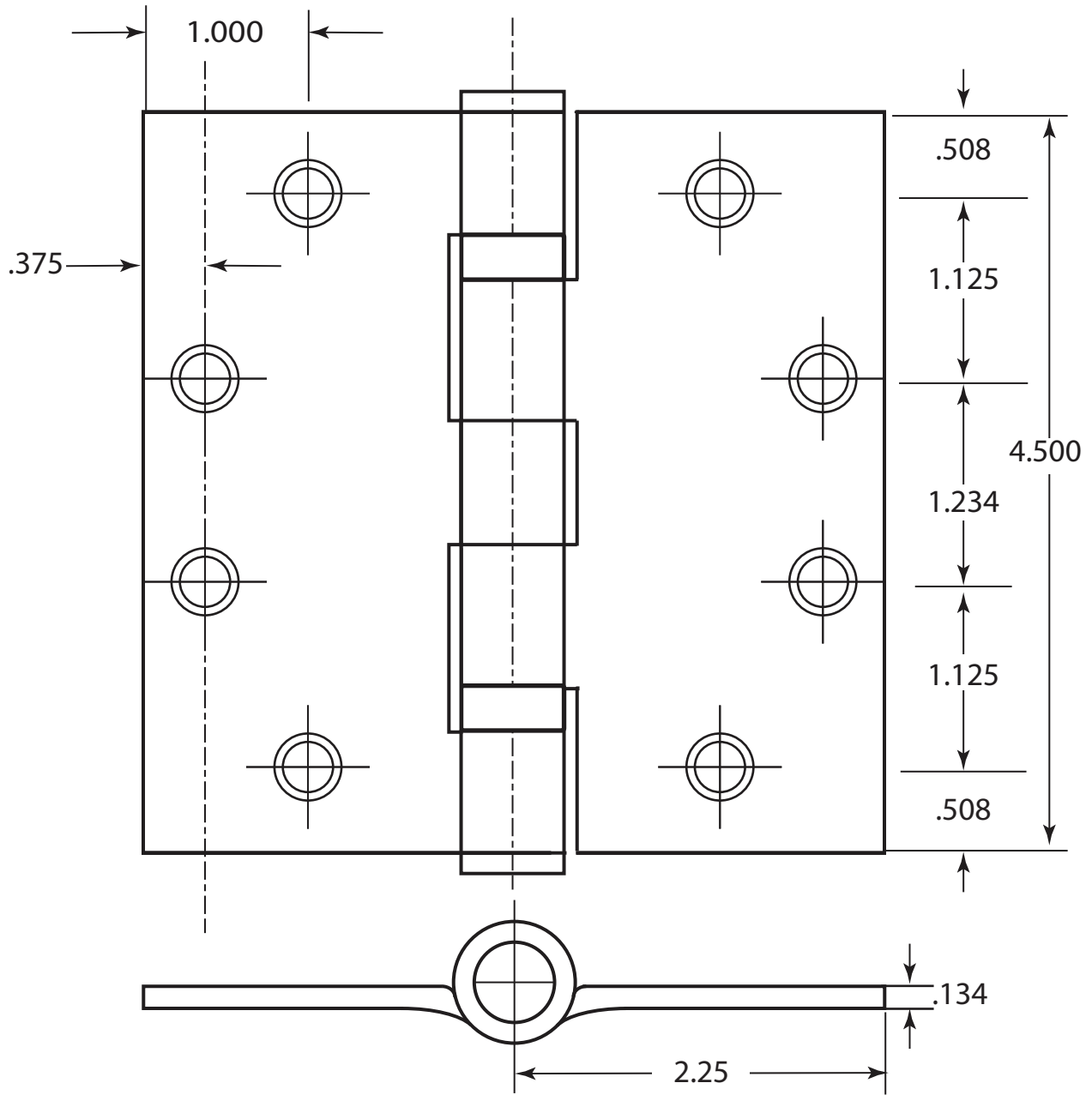

6605 Flotilla St.
 City of Commerce
 CA 90040 USA
 Tel: (323) 888-6601
 FAX: (323) 888-6699
 Website: cal-royal.com
 Email: sales@cal-royal.com

ITEM NO.:	DESCRIPTION:	SCALE:
BB-31	STANDARD WEIGHT HINGE TWO BALL BEARING FULL MORTISE TEMPLATE 4-1/2" X 4-1/2" SQUARE CORNER	1:1
ANSI:	UNIT:	VERSION:
A156.1	inches (mm)	ver. 1.0 rev. 01/12
		BY:
		bteves/jsa

Frame Anchors

STANDARD MANUFACTURING CONSTRUCTION DETAILS

ALL ANCHORS ARE MADE FROM 300 SERIES STAINLESS STEEL

New Masonry Wall Anchors

- 3 anchors per jamb up to 7' 6"
- 4 anchors per jamb up to 8' 0"
- 1 additional every 24"
- 1 Floor clip per jamb

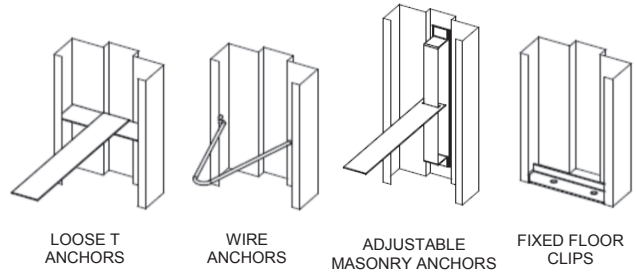

Stud Partition Wall Anchors

- 4 anchors per jamb up to 7' 6"
- 1 additional every 24"
- 1 Floor clip per jamb
- 2 anchors per head over 48"

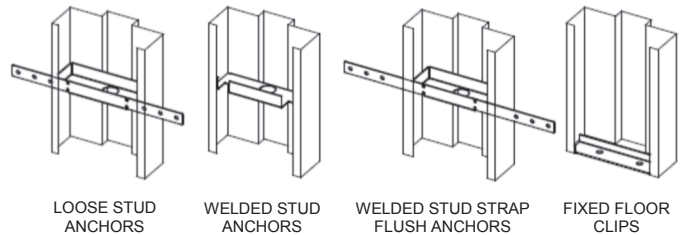

Existing Wall Anchors

- 6" From Top and Bottom
- Not more than 26" O.C.

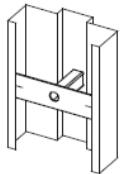

PIERCE & DIMPLE
EWA ANCHORS



3/8" x 5" SST
Masonry Bolt



3/8" x 4" SST
Wood Bolt

Snapshot - Pierce & Dimple

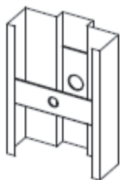
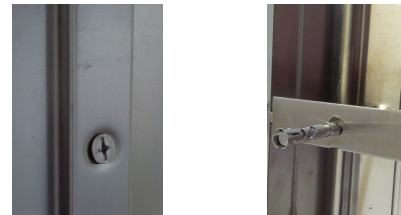

CONCEALED EWA
ANCHORS WITH CAPS



3/8" x 3" SST
Masonry Bolt



3/8" x 3" SST
Wood Bolt

Snapshot - Concealed

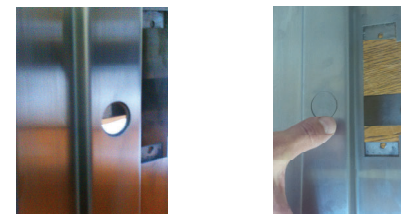

>>All specifications are subject to change without notice<<



Frame Anchor Bolts

Pierce And Dimple	
	# 1192 - 3/8" x 6" Masonry Expansion Bolt
	# 1231 - 3/8" x 5" Masonry Expansion Bolt
	# 1271 - #24 x 4" Wood Screw
Concealed Existing Wall	
	# 1232 - 3/8" x 3" Masonry Expansion Bolt
	# 1236 - 3/8" x 3" Wood Lag Bolt
	# 1101 - 3/8"-16 x 1" Machine Bolt
	# 1225 - #14 x 1" Sheet Metal Screw

>>All specifications are subject to change without notice<<

