

You can't beat the system.®

Submittal Package Cast Iron No-Hub System

[Updated April 20, 2022]

© 2018-2022 Charlotte Pipe and Foundry Company

SUBMITTAL PACKAGE

Table of Contents for Cast Iron No-Hub Submittal Package

	Page
Submittal Form for Cast Iron No-Hub Pipe & Fittings.....	3
Certifications	4
ASTM & CISPI Reference Standards.....	5
Gray Iron Properties & Composition.....	6
Dimensional Information	7-24
Submittal Form for Charlotte Standard No-Hub Couplings	25-26
Submittal Form for Charlotte Heavy-Duty (MD) No-Hub Couplings.....	27-28
Submittal Form for Charlotte Heavy-Duty (HD) No-Hub Couplings.....	29-30
Submittal Form for Charlotte 12" and 15" Heavy-Duty No-Hub Couplings.....	31-32
Limited Warranty.....	33

SUBMITTAL FOR CHARLOTTE PIPE® HUBLESS CAST IRON SOIL PIPE AND FITTINGS

Date: _____

Job Name: _____

Location: _____

Engineer: _____

Contractor: _____

► Scope:

This specification covers Hubless Cast Iron pipe, fittings, and couplings used in sanitary drain, waste and vent (DWV), sewer, and storm drainage applications. This system is intended for use in non-pressure applications.

► Specification:

Hubless Cast Iron pipe and fittings shall be manufactured from gray cast iron and shall conform to ASTM A 888 and CISPI Standard 301. All pipe and fittings shall be marked with the collective trademark of the Cast Iron Soil Pipe Institute® and listed by NSF® International. Hubless Couplings shall conform to CISPI Standard 310, shall be manufactured in the United States, and be certified by NSF® International. Heavy Duty and Medium Duty couplings shall conform to ASTM C 1540, shall be manufactured in the United States, and shall be used if indicated.

► Installation:

Installation shall comply with the latest installation instructions published by Charlotte Pipe and Foundry Company® and shall conform to all applicable plumbing, fire, and building code requirements. The system shall be hydrostatically tested after installation to 10 ft. of head (4.3 psi maximum). **WARNING!** Never test with or transport/store compressed air or gas in Cast Iron pipe or fittings. Doing so can result in explosive failures and cause severe injury or death.

► Referenced Standards:

- ASTM C 564: Rubber Gaskets for Cast Iron Soil Pipe and Fittings
- CISPI 301: Hubless Cast Iron Soil Pipe and Fittings
- CISPI 310: Hubless Couplings for Cast Iron Soil Pipe and Fittings
- ASTM C 1277: Hubless Couplings
- ASTM C 1540: Hubless Medium Duty and Heavy Duty Couplings



 1/4 Bend	 1/8 Bend	 Wye	 Combination
 San Tee	 San Cross	 Test Tee	 Reducer
 "P" Trap	 Blind Plug	 Figure Eight	 Two-Way Cleanout

Not all fitting patterns shown

TABLE 1
DIMENSIONS AND TOLERANCES (IN INCHES) OF SPIGOTS
AND BARRELS FOR NO-HUB PIPE AND FITTINGS

Size	Inside Barrel Diameter	Outside Diameter Barrel	Outside Diameter Spigot	Width Spigot Bead N	Thickness of Barrel	Gasket Positioning Lug
	B	J	M	(± .13)	T-Nom. T-Min.	W
1 1/2	1.50 ± .09	1.90 ± .06	1.96 ± .06	.25	.16	.13
2	1.96 ± .09	2.35 ± .09	2.41 ± .09	.25	.16	.13
3	2.96 ± .09	3.35 ± .09	3.41 ± .09	.25	.16	.13
4	3.94 ± .09	4.38 ± .09	4.44 ± .09	.31	.19	.15
5	4.94 ± .09	5.30 ± .09	5.36 ± .09	.31	.19	.15
6	5.94 ± .09	6.30 ± .09	6.36 ± .09	.31	.19	.15
8	7.94 ± .13	8.38 ± .09	8.44 ± .09	.31	.23	.17
10	10.00 ± .13	10.56 ± .09	10.62 ± .09	.31	.28	.22
12	11.94 ± .09	12.50 ± .13	12.62 ± .13	.31	.28	.22
15	15.11 ± .09	15.83 ± .13	16.12 ± .13	.31	.36	.25

Note: Charlotte Pipe does not recommend or warrant installations joined with unshielded hubless couplings.

Charlotte Pipe and Foundry Company • P.O. Box 35430 Charlotte, NC 28235 • (800) 438-6091 • www.charlottepipe.com

CHARLOTTE

PIPE AND FOUNDRY COMPANY®

Certifications

This is to verify that products manufactured by Charlotte Pipe and Foundry, Cast Iron Division, are manufactured in the United States and conform to the following standards:

SERVICE HUB AND SPIGOT PIPE AND FITTINGS

All cast iron soil pipe and fittings shall be marked with the collective trademark of the Cast Iron Soil Pipe Institute (CISPI).
ASTM A 74
Listed by NSF® International to the UP Code
ISO 9001:2015 Certified

EXTRA HEAVY HUB AND SPIGOT PIPE AND FITTINGS

All cast iron soil pipe and fittings shall be marked with the collective trademark of the Cast Iron Soil Pipe Institute (CISPI).
ASTM A 74
Listed by NSF® International to the UP Code
ISO 9001:2015 Certified

NO-HUB PIPE AND FITTINGS

All cast iron soil pipe and fittings shall be marked with the collective trademark of the Cast Iron Soil Pipe Institute (CISPI).
CISPI Standard 301
ASTM A 888
Listed by NSF® International to the UP Code
ISO 9001:2015 Certified

NO-HUB STANDARD COUPLINGS

CISPI Standard 310
ASTM C 1277
Certified by NSF® International

NO-HUB HEAVY DUTY (MD) COUPLINGS

ASTM C 1540
Factory Mutual 1680

NO-HUB HEAVY DUTY (HD) COUPLINGS

ASTM C 1540
Factory Mutual 1680

COMPRESSION GASKETS

ASTM C 564
CISPI HSN 85

Very truly yours,



Hooper Hardison, President

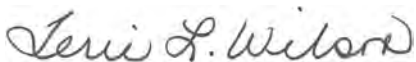

Notary Public
My commission expires July 02, 2022

LC-CI (10-15-19)

TERRI L WILSON
NOTARY PUBLIC
UNION COUNTY, NC
My Commission Expires 7-2-2022



Reference Standards Cast Iron

AMERICAN SOCIETY FOR TESTING AND MATERIALS

ASTM	TITLE
A 74	SPECIFICATION FOR CAST IRON SOIL PIPE AND FITTINGS HUB AND SPIGOT (SERVICE AND EXTRA HEAVY)
SCOPE:	THIS SPECIFICATION COVERS CAST IRON PIPE AND FITTINGS USED IN SANITARY DRAIN, WASTE, AND VENT (DWV), SEWER, AND STORM DRAINAGE APPLICATION. THIS SYSTEM IS INTENDED FOR USE IN NONPRESSURE APPLICATIONS.
C 564	SPECIFICATION FOR RUBBER GASKETS FOR CAST IRON SOIL PIPE AND FITTINGS
SCOPE:	THIS SPECIFICATION COVERS PREFORMED RUBBER GASKETS USED TO SEAL JOINTS IN CAST IRON SOIL PIPE AND FITTINGS.
C 1277	SPECIFICATION FOR COUPLING FOR USE IN CONNECTION WITH HUBLESS CAST IRON PIPE AND FITTINGS FOR SANITARY AND STORM DRAIN, WASTE, AND VENT PIPING APPLICATION (REGULAR HUBLESS COUPLING)
SCOPE:	THE PURPOSE OF THIS SPECIFICATION IS TO ESTABLISH CRITERIA FOR MATERIAL DIMENSIONS AND TOLERANCES FOR ONE TYPE OF COUPLING USED IN HUBLESS CAST IRON SOIL PIPE AND FITTING FOR SANITARY AND STORM DRAIN, WASTE AND VENT PIPING APPLICATIONS.
C 1540	SPECIFICATION FOR SHIELDED COUPLINGS JOINING HUBLESS CAST IRON SOIL PIPE AND FITTINGS (HEAVY DUTY COUPLINGS)
SCOPE:	THIS SPECIFICATION COVERS THE EVALUATION OF THE PERFORMANCE OF SHIELDED HUBLESS COUPLINGS TO JOIN CAST IRON SOIL PIPE AND FITTINGS.

CAST IRON SOIL PIPE INSTITUTE

CISPI	TITLE
301	SPECIFICATION FOR HUBLESS CAST IRON SOIL PIPE AND FITTINGS FOR SANITARY AND STORM DRAIN, WASTE, AND VENT PIPING APPLICATIONS
SCOPE:	THE PURPOSE OF THIS STANDARD IS TO ESTABLISH STANDARDS COVERING MATERIAL, DIMENSIONS, AND TOLERANCE FOR PIPE AND FITTINGS FOR HUBLESS CAST IRON SANITARY AND STORM DRAIN, SANITARY WASTE, AND VENT PIPING APPLICATIONS.
310	SPECIFICATION FOR COUPLING FOR USE IN CONNECTION WITH HUBLESS CAST IRON PIPE AND FITTINGS FOR SANITARY AND STORM DRAIN, WASTE, AND VENT PIPING APPLICATION (REGULAR HUBLESS COUPLING)
SCOPE:	THE PURPOSE OF THIS SPECIFICATION IS TO ESTABLISH CRITERIA FOR MATERIAL DIMENSIONS AND TOLERANCES FOR ONE TYPE OF COUPLING USED IN HUBLESS CAST IRON SOIL PIPE AND FITTING FOR SANITARY AND STORM DRAIN, WASTE AND VENT PIPING APPLICATIONS.

Gray Iron Physical Properties

Tensile Strength	20,000 p.s.i. — 60,000 p.s.i. (21,000 p.s.i.)
Elastic Modulus (Young's modulus)	10 - 23 x 10 ⁶ p.s.i.
Hardness (Brinell)	150 - 250 BHN
Thermal Conductivity	0.110 - 0.137 calories/cm ² /Sec/cm/ °C
Thermal Expansion	10 x 10 ⁻⁶ / °C 6 x 10 ⁻⁶ / °F
Density	0.25 - 0.28 lb./in ³ 6.95 - 7.35 gm/cm ³
Specific Heat	0.13 BTU / lb / °F 0.13 cal / gm / °C

Composition of Gray Iron

The following are typical ranges of elements present in unalloyed gray cast iron normally produced in commercial practice:

Carbon (C)	2.60 - 3.85%
Silicon (Si)	1.25 - 2.90%
Manganese (Mn)	0.40 - 1.00%
Phosphorus (P)	0.02 - 0.90%
Sulfur (S)	0.04 - 0.20%

Hubless Cast Iron

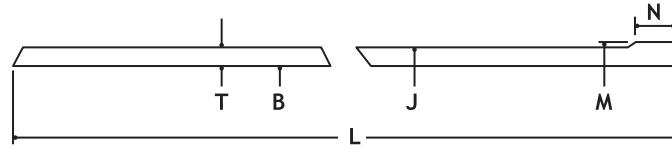

DIMENSIONS AND TOLERANCES (IN INCHES) OF SPIGOTS AND BARRELS FOR HUBLESS PIPE AND FITTINGS

Size	Inside Barrel Diameter	Outside Diameter Barrel	Outside Diameter Spigot	Width Spigot Bead N	Thickness of Barrel		Gasket Positioning Lug
	B	J	M	(± .13)	T-Nom.	T-Min.	W
1½	1.50 ± .09	1.90 ± .06	1.96 ± .06	.25	.16	.13	1.13
2	1.96 ± .09	2.35 ± .09	2.41 ± .09	.25	.16	.13	1.13
3	2.96 ± .09	3.35 ± .09	3.41 ± .09	.25	.16	.13	1.13
4	3.94 ± .09	4.38 ± .09	4.44 ± .09	.31	.19	.15	1.13
5	4.94 ± .09	5.30 ± .09 - .05	5.36 ± .09	.31	.19	.15	1.50
6	5.94 ± .09	6.30 ± .09 - .05	6.36 ± .09	.31	.19	.15	1.50
8	7.94 ± .13	8.38 ± .09	8.44 ± .09	.31	.23	.17	2.00
10	10.00 ± .13	10.56 ± .09	10.62 ± .09	.31	.28	.22	2.00
12	11.94 ± .09	12.50 ± .13	12.62 ± .13	.31	.28	.22	2.75
15	15.11 ± .09	15.83 ± .13	16.12 ± .13	.31	.36	.30	2.75

! WARNING

Cast Iron pipe and fittings are only intended for DWV (drain, waste and vent) non-pressure applications. Using cast iron pipe and fittings in pressure applications could result in explosive failures, causing serious injury or death or property damage.

! WARNING

Testing with or use of compressed air or gas in Cast Iron pipe or fittings can result in explosive failures and cause severe injury or death.



- NEVER test with or transport/store compressed air or gas in Cast Iron pipe or fittings.
- NEVER test Cast Iron pipe or fittings with compressed air or gas.
- ONLY use Cast Iron pipe and fittings for drain, waste and vent or sanitary sewer applications.

Hubless Cast Iron

Hubless Cast Iron Soil Pipe

Part No. NH 2 No-Hub (Hubless) Pipe

PIPE® The Gold Pipe® USA CHARLOTTE PIPE® USA

Size	Weight
1½"x10'	28.5
2"x10'	35.0
3"x10'	54.0
4"x10'	76.0
5"x10'	97.6
6"x10'	117.8
8"x10'	170.9
10"x10'	254.6
12"x10'	318.1
15"x10'	492.6



WARNING

Cast Iron pipe and fittings are only intended for DWV (drain, waste and vent) non-pressure applications. Using cast iron pipe and fittings in pressure applications could result in explosive failures, causing serious injury or death or property damage.



WARNING

Testing with or use of compressed air or gas in Cast Iron pipe or fittings can result in explosive failures and cause severe injury or death.

AIR/GAS



- NEVER test with or transport/store compressed air or gas in Cast Iron pipe or fittings.
- NEVER test Cast Iron pipe or fittings with compressed air or gas.
- ONLY use Cast Iron pipe and fittings for drain, waste and vent or sanitary sewer applications.

Hubless Cast Iron

PART NO. NH 1

No-Hub (Standard) Coupling

Size	Shield Width	Number of Clamps
1½	2.13"	2
2 x 1½	2.13"	2
2	2.13"	2
3 x 2	2.13"	2
3	2.13"	2
4 x 3	2.13"	2
4	2.13"	2
5	3.00"	4
6	3.00"	4
8	4.00"	4
10	4.00"	4



PART NO. NH 2

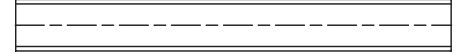

No-Hub Pipe - Ten Feet Laying Length

Size	Weight
1½" x 10'	28.5
2" x 10'	35.0
3" x 10'	54.0
4" x 10'	76.0
5" x 10'	97.6
6" x 10'	117.8
8" x 10'	170.9
10" x 10'	254.6
12" x 10'	318.1
15" x 10'	492.6

PART NO. MDC 2

Heavy Duty (MD) Coupling

Size	Shield Width	Number of Clamps
1½	3.00"	4
2	3.00"	4
3	3.00"	4
4	3.00"	4
5	4.00"	6
6	4.00"	6
8	4.00"	6
10	4.00"	6



PART NO. NH 4

Quarter Bend

Size	D	Weight
1½	4¼	1.7
2	4½	2.2
3	5	3.7
4	5½	6.5
5	6½	9.3
6	7	15.0
8	8½	23.1
4 x 3	5½	5.5

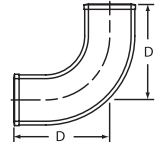

PART NO. SDC 4

Heavy Duty (HD) Coupling

Size	Shield Width	Number of Clamps
1½	3.00"	4
2	3.00"	4
3	3.00"	4
4	3.00"	4
5	4.00"	6
6	4.00"	6
8	4.00"	6
10	4.00"	6



Long Quarter Bend

Size	D	E	Weight
2 x 12	12	4½	5.4
2 x 18	18	4½	8.8
2 x 24	24	4½	10.7
3 x 12	12	5	8.5
4 x 12	12	5½	11.2

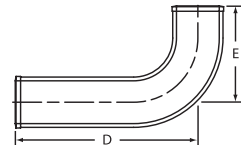

PART NO. HD 1

Heavy Duty Coupling

Size	Shield Width	Number of Clamps
12	5.50"	6
15	5.50"	6



PART NO. NH 4A

Tapped Quarter Bend

Size	D	E	Weight
1½ x 1½	3	2	1.9
2 x 1¼	3¼	2¼	2.0
2 x 1½	3¼	2¼	1.8
2 x 2	3¼	2¼	2.9

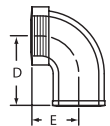

PART NO. NH 6

Quarter Bend with Side Opening

Size	E	D	Weight
3 x 2	3¼	4	5.1
4 x 2	3¾	4½ ₁₆	7.5

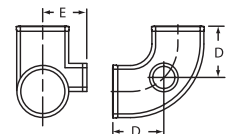

PART NO. NH 8

Quarter Bend with Heel Opening

Size	D	E	Weight
3 x 2	5	2 ⁷ / ₈	5.6
4 x 2	5 ¹ / ₂	3 ¹ / ₄	7.2

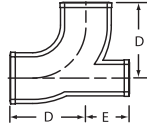

PART NO. NH 8A

Double Quarter Bend

Size	D	Weight
2	4 ¹ / ₂	4.5
3	5	7.1
4	5 ¹ / ₂	9.7

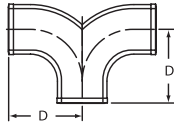

PART NO. NH 8B

Extended Quarter Bend with Low Heel Outlet

Size	D	E	Weight
3 x 2	5	10 ¹ / ₂	7.8

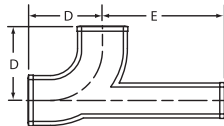

PART NO. NH 9

Fifth Bend

Size	D	Weight
2	3 ¹¹ / ₁₆	2.3
3	4 ¹ / ₁₆	3.7
4	4 ⁷ / ₁₆	6.1

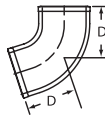

PART NO. NH 10

Sixth Bend

Size	D	Weight
2	3 ¹ / ₄	2.2
3	3 ¹ / ₂	3.0
4	3 ¹³ / ₁₆	5.3

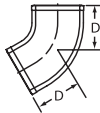

PART NO. NH 12

Eighth Bend

Size	D	Weight
1 ¹ / ₂	2 ⁵ / ₈	1.5
2	2 ³ / ₄	1.5
3	3	2.9
4	3 ¹ / ₈	4.0
5	3 ⁷ / ₈	7.4
6	4 ¹ / ₁₆	9.1
8	5	14.9
10	5 ¹⁵ / ₁₆	31.7
12	6 ⁹ / ₁₆	31.6
15	7 ¹³ / ₁₆	62.0

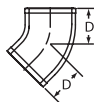

PART NO. NH 12

Long Eighth Bend

Size	D	E	Weight
2 x 12	12	2 ³ / ₄	4.6
2 x 18	18	2 ³ / ₄	7.3
3 x 12	12	3	8.0
3 x 18	18	3	10.2
4 x 12	12	3 ¹ / ₈	9.7

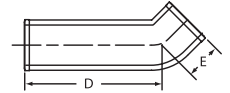

PART NO. NH 14

Sixteenth Bend

Size	D	Weight
1 ¹ / ₂	2 ¹ / ₈	1.2
2	2 ¹ / ₈	1.4
3	2 ¹ / ₄	2.1
4	2 ⁵ / ₁₆	3.4
5	2 ⁷ / ₈	5.4
6	3	6.7
8	3 ³ / ₄	12.0



PART NO. NH 16

Short Sweep

Size	D	Weight
2	6 ¹ / ₂	3.1
3	7	6.3
4	7 ¹ / ₂	8.1
5	8 ¹ / ₂	13.1
6	9	17.1
8	10 ¹ / ₂	31.0
10	12	53.4
12	13 ¹ / ₄	61.3
15	14 ³ / ₄	105.6

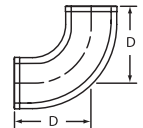

PART NO. EZS 14

Extended Short Sweep

Size	E	F	Weight
2 x 18	6 ¹ / ₂	18	8.0
2 x 24	6 ¹ / ₂	24	11.0
2 x 34	6 ¹ / ₂	34	13.9

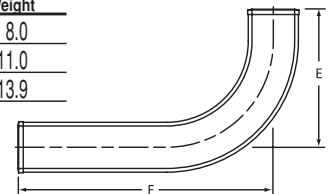

PART NO. NH 18

Long Sweep

Size	D	Weight
1 1/2	9 1/4	4.4
2	9 1/2	5.8
3	10	9.4
4	10 1/2	12.3
5	11 1/2	18.6
6	12	23.3

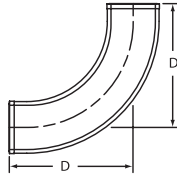

PART NO. NH 18

Reducing Long Sweep

Size	D	Weight
4 x 3	10 1/2	12.4

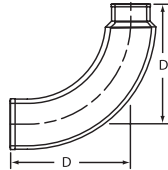

PART NO. NH 20

Wye

Size	D	F	G	Weight
1 1/2 x 1 1/2	4	6	2	2.5
2 x 2	4 5/8	6 5/8	2	3.3
3 x 1 1/2	4 5/8	6 1/8	1 15/16	4.4
3 x 2	5 5/16	6 5/8	1 1/2	3.4
3	5 3/4	8	2 1/4	4.6
4 x 2	6	6 5/8	1	5.1
4 x 3	6 1/2	8	1 11/16	7.3
4	7 1/16	9 1/2	2 7/16	9.1
5 x 2	7 1/2	8 1/16	1 9/16	8.8
5 x 3	8	9 11/16	1 11/16	10.5
5 x 4	8 1/2	11 3/16	2 7/16	13.1
5	9 1/2	12 5/8	3 1/8	15.1
6 x 2	8 1/4	8 5/16	1/2	9.8
6 x 3	8 3/4	9 3/4	1 1/4	12.5
6 x 4	9 1/4	11 3/16	1 15/16	14.6
6 x 5	10 1/4	12 1/2	2 9/16	17.6
6	10 3/4	14 1/16	3 5/16	19.7
8 x 3	9 3/16	9 15/16	1/8	17.5
8 x 4	10 3/8	11 7/16	1 9/16	22.0
8 x 5	11 3/8	12 3/16	1 5/8	23.9
8 x 6	11 13/16	14 3/16	2 5/16	28.3
8	13 3/8	17 1/8	3 3/4	36.3
10 x 4	11 11/16	12 5/8	3/4	32.9
10 x 6	13 3/8	15 7/16	2 3/16	42.1
10 x 8	14 11/16	18 3/8	3 5/8	56.1
10	16 1/2	21 1/2	5 1/16	74.9
12	19 3/4	25 1/2	5 3/4	97.0
15	23 1/4	30	6 3/4	189.5

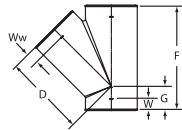

PART NO. NH 21

Double Wye

Size	D	F	Weight
2	4 5/8	6 5/8	4.5
3 x 2	5 5/16	6 5/8	5.5
3	5 3/4	8	7.9
4 x 2	6	6 5/8	6.5
4 x 3	6 1/2	8	8.8
4	7 1/16	9 1/2	12.1
5 x 4	8 1/2	11 3/16	15.7
6 x 4	9 1/4	11 3/16	16.4
6	10 3/4	14 1/16	27.4
8	13 3/8	17 1/8	45.3
8 x 4	10 3/8	11 7/16	23.0
8 x 6	11 13/16	14 3/16	31.3

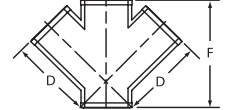

PART NO. NH 21A

Upright Wye

Size	H	E	F	G	Weight
2	8 1/4	5 1/2	7	2	4.8
3 x 2	8 3/16	5 1/2	7	1 1/2	5.7
3	8 7/16	5 1/2	8 3/8	2 3/16	9.5
4 x 2	8 1/4	5 1/2	7	1	7.7
4 x 3	8 7/16	5 1/2	8 3/8	1 11/16	10.1
4	9 1/8	6	9 3/4	2 7/16	12.9
5 x 2	9	6 1/8	8	1	11.0
5	11 7/16	7 1/8	12 3/4	2 3/4	19.9

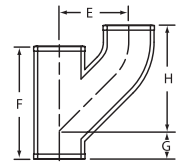

PART NO. NH 22

Combination

Size	D	E	F	Weight
1 1/2	4 3/4	5 3/8	6	3.1
2 x 1 1/2	5	5 7/8	6	3.4
2	5 3/8	6 1/8	6 5/8	3.5
3 x 1 1/2	5 1/2	6 3/4	6 5/8	5.0
3 x 2	5 1/2	6 3/4	6 5/8	5.7
3	7 5/16	8	8	8.5
4 x 2	5 1/2	7 1/4	6 5/8	6.6
4 x 3	7 1/4	8 1/2	8	9.5
4	9 1/4	10	9 1/2	13.7
5 x 2	5 15/16	7 3/4	8 1/16	8.5
5 x 3	7 3/4	9	9 11/16	12.0
5 x 4	9 3/4	10 1/2	11 3/16	17.1
5	11 3/4	12 1/2	12 5/8	19.7
6 x 2	6	8 1/4	8 5/16	12.0
6 x 3	7 13/16	9 1/2	9 3/4	14.7
6 x 4	9 3/4	11	11 3/16	18.4
6 x 5	11 11/16	13	12 1/2	23.4
6	13 5/8	14 3/8	14 1/16	30.0
8 x 4	9 7/16	11 5/16	11 3/16	25.1
8 x 6	12	13 3/8	13 15/16	35.4
8	14 3/4	15 9/16	16 15/16	49.3

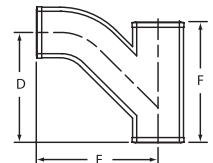

PART NO. EZS 15

Extended Combination

Size	E	F	G	Weight
2 x 24	6 ³ / ₁₆	25 ³ / ₈	24	12.0
2 x 36	6 ³ / ₁₆	36	34 ³ / ₄	15.4

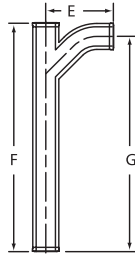

PART NO. NH 24

Double Combination

Size	D	E	F	Weight
2	5 ³ / ₈	6 ¹ / ₈	6 ⁵ / ₈	6.3
3 x 2	5 ¹ / ₂	6 ³ / ₄	6 ⁵ / ₈	7.7
3	7 ⁵ / ₁₆	8	8	11.8
4 x 2	5 ¹ / ₂	7 ¹ / ₄	6 ⁵ / ₈	8.3
4 x 3	7 ¹ / ₄	8 ¹ / ₂	8	13.7
4	9 ¹ / ₄	10	9 ¹ / ₂	20.5

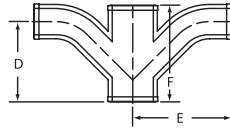

PART NO. NH 26

Tapped Wye

Size	D	F	Weight
2 x 1 ¹ / ₂	5 ¹ / ₁₆	6 ⁵ / ₈	3.4
2 x 2	5 ¹ / ₁₆	6 ⁵ / ₈	4.6
3 x 1 ¹ / ₂	5 ³ / ₄	6 ⁵ / ₈	5.1
3 x 2	5 ¹³ / ₁₆	6 ⁵ / ₈	5.3
4 x 1 ¹ / ₂	6 ⁷ / ₁₆	6 ⁵ / ₈	6.0
4 x 2	6 ¹ / ₂	6 ⁵ / ₈	7.2

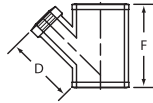

PART NO. NH 27

Tapped Double Wye

Size	D	F	Weight
2 x 1 ¹ / ₂	5 ¹ / ₁₆	6 ⁵ / ₈	5.6

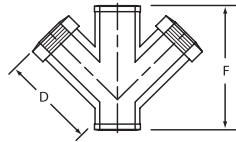

PART NO. NH 28

Sanitary Tee

Size	E	F	D	Weight
1 ¹ / ₂ x 1 ¹ / ₂	4 ¹ / ₄	6 ¹ / ₂	4 ¹ / ₄	2.9
2 x 1 ¹ / ₂	4 ¹ / ₂	6 ⁵ / ₈	4 ¹ / ₄	3.4
2	4 ¹ / ₂	6 ⁷ / ₈	4 ¹ / ₂	3.1
3 x 1 ¹ / ₂	5	6 ¹ / ₂	4 ¹ / ₄	4.5
3 x 2	5	6 ⁷ / ₈	4 ¹ / ₂	3.7
3	5	8	5	5.5
4 x 2	5 ¹ / ₂	6 ⁷ / ₈	4 ¹ / ₂	5.3
4 x 3	5 ¹ / ₂	8	5	7.6
4	5 ¹ / ₂	9 ¹ / ₈	5 ¹ / ₂	8.5
5 x 2	6 ¹ / ₂	8 ¹ / ₂	5	8.3
5 x 3	6	9 ⁵ / ₁₆	5 ¹ / ₂	10.2
5 x 4	6	10 ¹³ / ₃₂	6	11.5
5	6 ¹ / ₂	11 ⁷ / ₁₆	6 ¹ / ₂	12.5
6 x 2	6 ¹ / ₂	8 ³ / ₁₆	5	9.9
6 x 3	6 ¹ / ₂	9 ⁹ / ₁₆	5 ¹ / ₂	11.5
6 x 4	6 ¹ / ₂	10 ¹ / ₁₆	6	12.0
6 x 5	7	11 ¹ / ₂	6 ¹ / ₂	15.6
6	7	12 ¹ / ₂	7	12.9
8 x 3	7 ¹ / ₂	10 ³ / ₈	6	17.9
8 x 4	7 ¹ / ₂	11 ¹ / ₂	6 ¹ / ₂	21.6
8 x 5	8	12 ¹ / ₂	7	24.0
8 x 6	8	13 ¹ / ₂	7 ¹ / ₂	24.0
8	8 ¹ / ₂	15 ¹ / ₂	8 ¹ / ₂	30.8

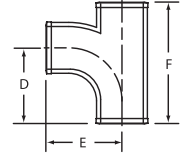

PART NO. EZS 16

2" x 24" Two-Way Sanitary Tee

Size	E	H	F	Weight
2 x 18	4 ¹ / ₂	4 ¹ / ₂	18	7.8
2 x 24	4 ¹ / ₂	4 ¹ / ₂	24	10.4
2 x 36	4 ¹ / ₂	4 ¹ / ₂	36	15.6

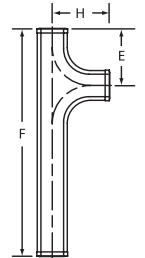

PART NO. NH 30

Sanitary Cross

Size	E	F	D	Weight
1 ¹ / ₂	4 ¹ / ₄	6 ¹ / ₂	4 ¹ / ₂	3.6
2	4 ¹ / ₂	6 ⁷ / ₈	4 ¹ / ₂	5.0
3 x 2	5	6 ⁷ / ₈	4 ¹ / ₂	6.2
3	5	8	5	7.6
4 x 2	5 ¹ / ₂	6 ⁷ / ₈	4 ¹ / ₂	7.3
4 x 3	5 ¹ / ₂	8	5	8.5
4	5 ¹ / ₂	9 ¹ / ₈	5 ¹ / ₂	11.0
5 x 4	6	10 ¹³ / ₃₂	6	13.4
6 x 4	6 ¹ / ₂	10 ¹ / ₁₆	6	14.0
6	7	12 ¹ / ₂	7	21.0
8 x 4	7 ¹ / ₂	11 ¹ / ₂	6 ¹ / ₂	23.0
8	8 ¹ / ₂	15 ¹ / ₂	8 ¹ / ₂	37.9

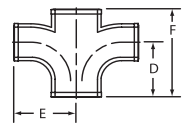

PART NO. NH 31

**Sanitary Tee with 2" 90° Sanitary Opening Above Center
(New Orleans Code)**

Size	C	D	E	F	G	Weight
3 (L)	4 1/2	6	5	8 1/2	5	6.7
3 (R)	4 1/2	6	5	8 1/2	5	6.3
4 (L)	5	6 1/2	5 1/2	9 3/16	5 1/2	8.6
4 (R)	5	6 1/2	5 1/2	9 3/16	5 1/2	8.5

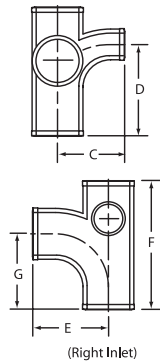

PART NO. NH 32

**Sanitary Tee with 2" Side Inlets
Right Hand and Left Hand**

Size	E	F	D	Weight
4 x 4 w/RH & LH	5 9/16	9 1/8	5 1/2	10.9

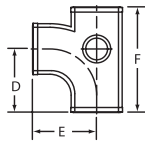

PART NO. NH 32B

**Sanitary Tee with 2" 45° Sanitary Opening Above Center
(New Orleans Code)**

Size	D	E	F	G	Weight
3 (L)	6	5	8 1/2	5	8.2
3 (R)	6	5	8 1/2	5	7.8
3 (R&L)	6	5	8 1/2	5	9.1
4 (L)	6 1/2	5 1/2	9 3/16	5 1/2	9.6
4 (R)	6 1/2	5 1/2	9 3/16	5 1/2	9.4

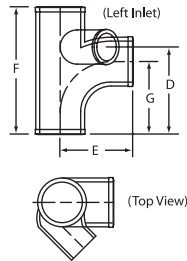

PART NO. NH 33A

**Sanitary Cross with 2" 90° Sanitary Openings Above Center
(New Orleans Code)**

Size	C	D	E	F	G	Weight
4	5	6 1/2	5 1/2	9 3/16	5 1/2	10.8

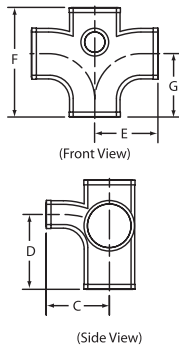

PART NO. NH 33C

**Sanitary Cross with Two 2" 90° Sanitary Openings Above Center
(New Orleans Code)**

Size	C	D	E	F	G	Weight
3	4 1/2	6	5	8 1/2	5	9.0
4	5	6 1/2	5 1/2	9 3/16	5 1/2	11.9

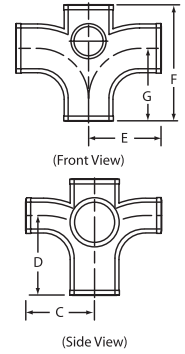

PART NO. NH 33F

**Sanitary Cross with Two 2" 45° Sanitary Openings Same Side
(New Orleans Code)**

Size	D	E	F	G	Weight
3	6	5	8 1/2	5	9.8
4	5 1/2	5 1/2	9 1/16	5 1/2	13.8

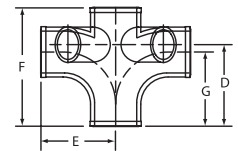

PART NO. NH 33G

Sanitary Cross with 3" Vent and Two 2" 45° Inlets

Size	A	B	C	F	G	Weight
4x3x4x2x2	3 3/4	5 1/4	4 3/4	10 1/2	6 1/2	24.0

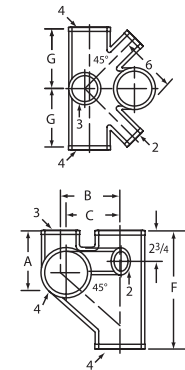

PART NO. NH 34

Sanitary Tapped Tee

Size	D	E	F	Weight
1 1/2 x 1 1/4	3 1/4	2 9/16	5 11/16	2.3
1 1/2 x 1 1/2	3 1/4	2 9/16	5 11/16	2.5
2 x 1 1/4	3 1/4	2 13/16	5 11/16	2.8
2 x 1 1/2	3 1/4	2 13/16	5 11/16	3.1
2 x 2	3 3/4	3 1/16	6 3/8	3.8
3 x 1 1/4	3 1/4	3 5/16	5 11/16	3.7
3 x 1 1/2	3 1/4	3 5/16	5 11/16	3.6
3 x 2	3 3/4	3 9/16	6 3/8	4.9
3 x 3	4 7/8	4 1/8	8	7.3
4 x 1 1/4	3 1/4	3 13/16	5 11/16	4.0
4 x 1 1/2	3 1/4	3 3/4	5 11/16	4.8
4 x 2	3 3/4	4 1/16	6 3/8	5.8
4 x 3	4 1/2	4 3/8	8	8.4
5 x 1 1/2	3 3/4	4 5/16	7 3/16	6.5
5 x 2	4 1/4	4 9/16	8	9.3
6 x 1 1/2	3 3/4	4 13/16	6 3/4	8.4
6 x 2	4 1/4	5 1/16	7 7/16	9.2

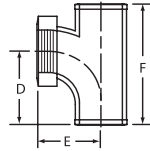

PART NO. EZS 17

2" x 22 7/8" Extended Tapped Sanitary Tee

Size	H	F	Weight
2 x 1 1/2 x 22 7/8	3 1/4	22 7/8	9.6
2 x 2 x 22 7/8	3 3/4	22 7/8	9.2



PART NO. EZS 27

Sanitary Tapped Tee

Size	H	F	Weight
2 x 1 1/2 x 31	11 1/4	31	12.6
2 x 2 x 31	11 1/4	31	13.6

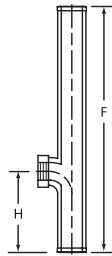

PART NO. NH 35

Sanitary Tapped Cross

Size	D	E	F	Weight
1 1/2 x 1 1/2	3 1/4	2 9/16	5 11/16	3.4
2 x 1 1/4	3 1/4	2 13/16	5 11/16	3.9
2 x 1 1/2	3 1/4	2 13/16	5 11/16	4.0
2 x 2	3 3/4	3 1/16	6 3/8	5.3
3 x 1 1/2	3 1/4	3 5/16	5 11/16	4.3
3 x 2	3 3/4	3 9/16	6 3/8	6.1
4 x 1 1/2	3 1/4	3 3/4	5 11/16	5.5
4 x 2	3 3/4	4 1/16	6 3/8	6.9

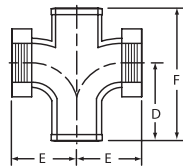

PART NO. EZS 18

2" x 22 7/8" Extended Tapped Sanitary Cross

Size	H	F	Weight
2 x 1 1/2 x 22 7/8	3 1/4	22 7/8	10.0
2 x 2 x 22 7/8	3 3/4	22 7/8	11.9

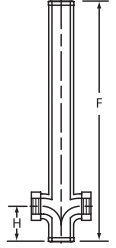

PART NO. EZS 28

Sanitary Tapped Cross

Size	H	F	Weight
2 x 1 1/2 x 31	11 1/4	31	15.0
2 x 2 x 31	11 1/4	31	15.0

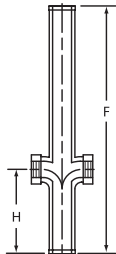

PART NO. NH 35B

Double Vertical Sanitary Tapped Tee

Size	E	F	G	H	Weight
2 x 1 1/2	2 13/16	9 3/4	4 1/2	3 1/4	4.8

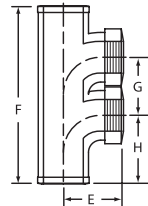

PART NO. NH 36

Test Tee Less Plug

and PART NO. NH 36S

Test Tee with Southern Raised-Head Brass Plug Installed (2" through 8" only)

Size	IPS Tap	E	F	D	D'	Weight
2	2	2	6 3/8	3 3/16	3 3/16	3.0
3	3	2 11/16	7 3/4	3 7/8	3 7/8	5.8
4	4	3	8 7/8	4 7/16	4 7/16	9.2
5	5	4 1/2	11 1/2	5 3/4	5 3/4	15.2
6	6	5	12 1/2	6 1/4	6 1/4	22.0
8	8	6	15 1/4	7 5/8	7 5/8	37.1
10	10	6 1/2	20	10	10	59.7
4 x 3	3 1/2	2 7/8	9 1/2	5	4 1/2	8.0

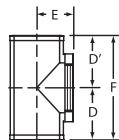

PART NO. NH 40

Increaser-Reducer

Size	F	Weight
2 x 3	8	3.8
2 x 4	8	4.4
3 x 4	8	5.0

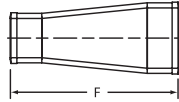

PART NO. NH 40A

Short Reducer

Size	F	Weight
2 x 1 1/2	3 5/8	1.1
3 x 1 1/2	3 5/8	1.8
3 x 2	3 5/8	1.8
4 x 2	3 5/8	2.3
4 x 3	3 5/8	2.3
5 x 2	4	3.3
5 x 3	4	3.8
5 x 4	4	3.2
6 x 2	4	4.3
6 x 3	4	3.7
6 x 4	4	4.1
6 x 5	4 1/2	4.3
8 x 2	4 1/2	7.0
8 x 3	4 1/2	7.6
8 x 4	4 1/2	7.7
8 x 5	5	7.3
8 x 6	5	8.0
10 x 4	5 1/2	12.5
10 x 6	6	13.3
10 x 8	6	14.9
12 x 4	6 1/2	19.1
12 x 6	6 1/2	18.3
12 x 8	7	17.3
12 x 10	7 1/2	18.9
15 x 4	7	30.0
15 x 6	7	31.8
15 x 8	7	32.2
15 x 10	7 1/2	32.2
15 x 12	7 3/4	30.5

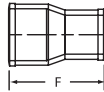

PART NO. NH 42

P-Trap

Size	D	J	Weight
1 1/2	6 3/4	3 1/2	3.4
2	7 1/2	4	4.7
3	9	5 1/2	8.9
4	10 1/2	6 1/2	17.0
6	14	8 1/2	33.6

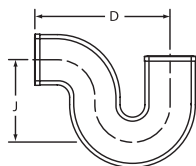

PART NO. NH 42

Long P-Trap

Size	D	J	Weight
2 x 12	12	4	6.1
2 x 18	18	4	8.0

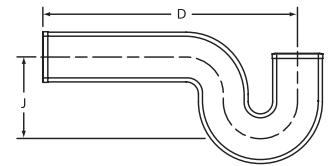

PART NO. NH 42A

P-Trap, Reducing

Size	D	J	Weight
3 x 2	9	5 1/2	10.0

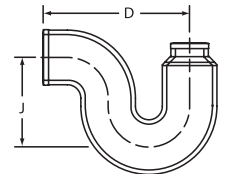

PART NO. NH 42B

P Trap with 1/2" Tap in Heel

Size	C	D	E	J	Weight
6	8	14	2 3/4	8 1/2	33.6

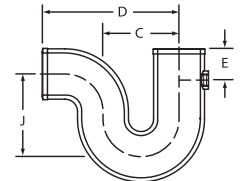

PART NO. NH 43

P Trap with 1/2" Tap in Heel

Size	C	D	E	J	Weight
2	4	7 1/2	2	4	4.7
3	5	9	2	5 1/2	10.8
4	6	10 1/2	2	6 1/2	18.8

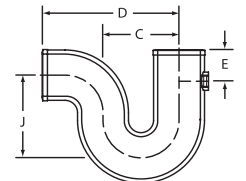

PART NO. EZS 9

P-Trap with 1 1/2" Tapped Side Inlet

Size	H	F	Weight
2	5 3/16	7 1/2	6.2

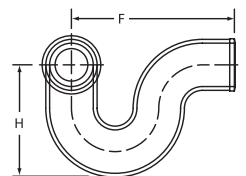

(Illustration Shows Right Hand)

PART NO. EZS 10

P-Trap with 2" Side Inlet

Size	C	D	J	Weight
2	1 ³ / ₁₆	7 ¹ / ₂	3 ¹ / ₁₆	6.4

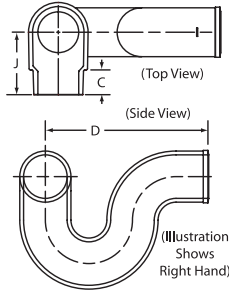

PART NO. NH 44

P-Trap with Tapped Inlet

Size	C	D	J	Weight
1 ¹ / ₂ x 1 ¹ / ₂	3 ¹ / ₂	6 ³ / ₄	3 ¹ / ₂	3.0
2 x 1 ¹ / ₂	4	7 ¹ / ₂	4	4.5
2 x 2	4	7 ¹ / ₂	4	5.4

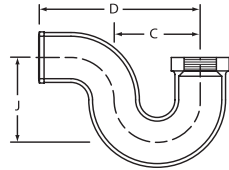

PART NO. NH 44A

Deep Seal P Trap

Size	C	D	J	Weight
2	4	7 ¹ / ₂	7	6.6
3	5	9	7	11.0
4	6	10 ¹ / ₂	8	18.6

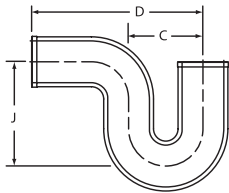

PART NO. NH 45

Running Trap with Vent

Size	D	E	F	G	Weight
4	6 ¹ / ₂	4 ¹ / ₂	15	10 ¹ / ₂	20.5

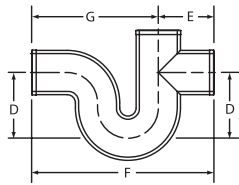

PART NO. NH 45A

Running Trap with Double Vent

Size	C	D	E	F	G	Weight
4	6	6 ¹ / ₂	4 ¹ / ₂	15	10 ¹ / ₂	21.4

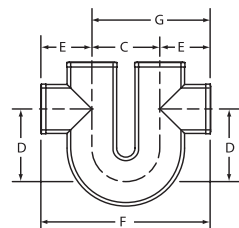

PART NO. EZS 13

45° Vented Tub Wye

Size	E	F	G	Weight
2	12	5 ¹ / ₄	15 ³ / ₄	10.1

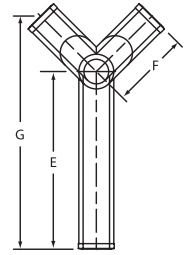

PART NO. EZS 38

Vented Tub Wye

Size	G	H	F	Weight
2	9 ¹ / ₂	5 ¹ / ₄	15	9.4
2	24	5 ¹ / ₄	29 ¹ / ₂	13.7

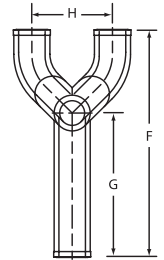

PART NO. EZS 38 L

Vented Tub Wye Left Hand

Size	G	H	F	Weight
2	9 ¹ / ₂	3 ³ / ₄	15	10.0

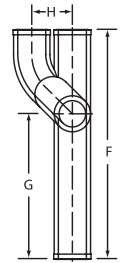

PART NO. EZS 38 R

Vented Tub Wye Right Hand

Size	G	H	F	Weight
2	9 ¹ / ₂	3 ³ / ₄	15	9.0

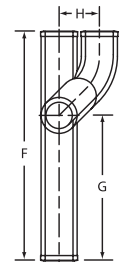

PART NO. NH 48

Tapped Adapters

Size	F	IPS Tapping	Weight
1 ¹ / ₂ x 1 ¹ / ₂	2 ⁵ / ₈	1 ¹ / ₂	1.3
2 x 1 ¹ / ₄	2 ³ / ₁₆	1 ¹ / ₄	1.0
2 x 1 ¹ / ₂	2 ³ / ₁₆	1 ¹ / ₂	0.9
2 x 2	2 ⁵ / ₈	2	1.7
3 x 2	2 ³ / ₁₆	2	1.0

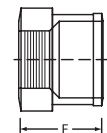

PART NO. NH 50

Blind Plug

Size	F	Weight
1 1/2	1 3/4	0.6
2	1 3/4	0.7
3	1 3/4	1.1
4	1 3/4	2.0
5	1 3/4	2.9
6	1 3/4	3.2
8	2 1/4	6.5
10	3	14.7
12	3 1/2	17.6
15	3 1/2	28.0

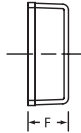

PART NO. NH 52

Tapped Ferrule Less Brass Plug and PART NO. NH 52S

Tapped Ferrule with Southern Raised-Head Brass Plug Installed

Size	F	IPS Tapping	Weight
2	2 3/16	1 1/2	0.9
3	2 3/16	2 1/2	1.9
4	2 3/16	3 1/2	2.5
5	4 1/2	4	6.5
6	4 1/2	5	8.0
8	4 1/2	6	12.1



PART NO. NH 53

Single Two-Way Cleanout

Size	E	F	Weight
4	7 1/2	15	16.0

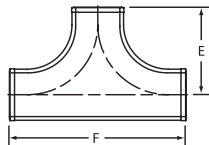

PART NO. NH 53A

Two-Way Cleanout

Size	D	E	F	G	Weight
4	8 1/4	2 3/4	12	6 1/2	15.0

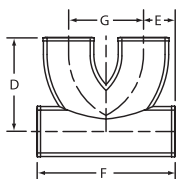

PART NO. NH 54

Two-Way Baffle Cleanout

Size	D	F	Weight
3 x 3 x 4	15	9	14.2
4 x 4 x 4	18 3/8	9 1/2	22.0

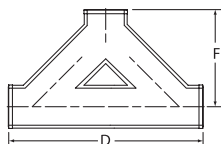

PART NO. NH 56

Notched and Slotted Closet Collar

Size	D	E	F	A	Weight
4 x 3	3 1/2	3 3/8	7 1/4	4 7/32	3.3
4 x 3	8	3 27/64	7 1/4	4	6.1
4 x 4	4	4 3/8	7 1/4	4 9/64	4.7
4 x 4	8	4 3/8	7 1/4	4 7/32	7.0

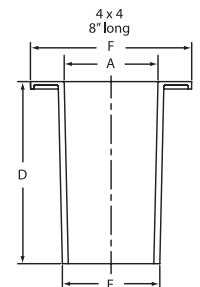
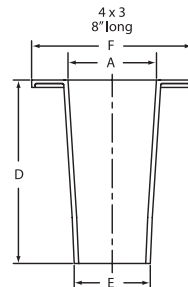
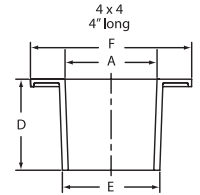
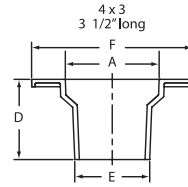

PART NO. NH 57

Horizontal Twin Tapped Tee

Size	A	D	F	H	Weight
3 x 1 1/2	1 3/8	4	7	3	7.3
4 x 1 1/2	1 3/8	4	7	3	8.0

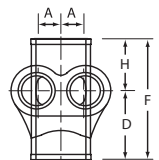

PART NO. NH 457

Vented Closet Tee with 2" Top Vent

(Left or Right; Designed for use below the floor; Fitting does not require a baffle)

Size	B	C	D	E	F	G	Wt.
4x4x2x4(L)	4 1/4	5 1/4	3 3/4	4	10 1/2	3 3/4	12.1
4x4x2x4(R)	4 1/4	5 1/4	3 3/4	4	10 1/2	3 3/4	11.

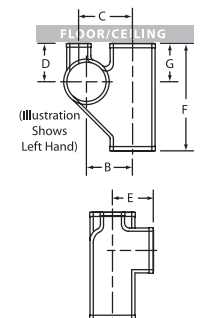

PART NO. NH 458

**Vented Closet Tee
with 2" Top Vent and 2" Side Opening**
(Left or Right; Designed for use below the floor;
Fitting does not require a baffle)

Size	A	B	C	D	E	F	G	Wt.
4x4x2x2x4(L)	8 1/8	4 1/4	5 1/4	7 1/2	4	10 1/2	3 3/4	12.3
4x4x2x2x4(R)	8 1/8	4 1/4	5 1/4	7 1/2	4	10 1/2	3 3/4	12.2

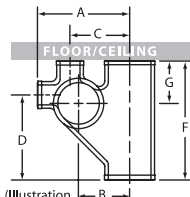

(Illustration Shows Left Hand)

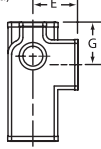

PART NO. NH 463

Vented Closet Cross with 2" Top Vent
(Designed for use below the floor;
Fitting has a baffle)

Size	B	C	D	E	F	G	Wt.
4x4x2x4x4	4 1/4	5 1/4	3 3/4	4	10 1/2	3 3/4	15.0

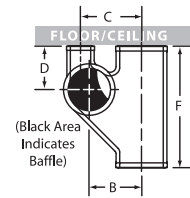

(Black Area Indicates Baffle)

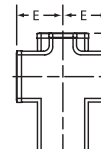

PART NO. NH 464

**Vented Closet Cross with 2" Top Vent
and 2" Side Opening**
(Designed for use below the floor;
Fitting has a baffle)

Size	A	B	C	D	E	F	G	Wt.
4x4x2x2x4x4	8 1/8	4 1/4	5 1/4	7 1/2	4	10 1/2	3 3/4	15.6

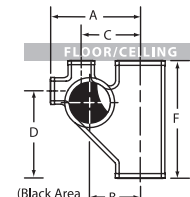

(Black Area Indicates Baffle)

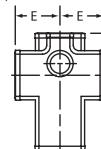

PART NO. NH 502

4" No Hub Prison Fitting with 2" Top Vent
(Designed for use above the floor; Baffle helps prevent
passage of contraband between cells)

Part No.	Size	UPC# 611942-	A	C	F	G	Weight
NH 502	4 Less Tap	00639	8	5 1/4	12	8	20.3
NH 502	4 With Tap	00640	8	5 1/4	12	8	20.8
NH 502	4x3 Less Tap	11119	8	5 1/4	12	8	23.4
NH 502	4x3 With Tap	11120	8	5 1/4	12	8	23.4

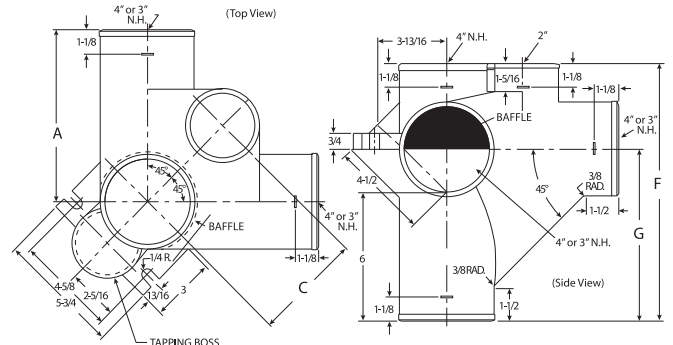

PART NO. EZS 50*

10" Closet Fittings with 2" Inlet
(Double, Left Hand or Right Hand; Designed for use below the floor;
Fitting does not have a baffle)

Part No.	Size	UPC# 611942-	A	B	C	D	F	Weight
EZS 50D***	4	04484	10 3/4	6 1/2	3 3/4	4	4 1/2	15.0
EZS 50L	4	04476	10 3/4	6 1/2	3 3/4	4	4 1/2	12.3
EZS 50R	4	04477	10 3/4	6 1/2	3 3/4	4	4 1/2	12.2

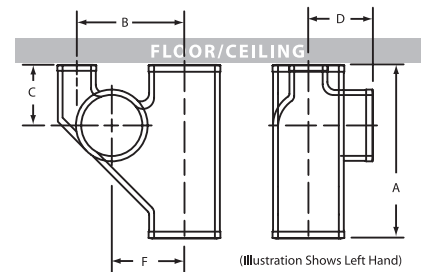

(Illustration Shows Left Hand)

* When ordering please specify Double, Left or Right.
*** Double closet fitting does not have a baffle.

PART NO. EZS 51*

10" Closet Fittings with 2" Inlet and 2" Side Inlet
(Double, Left Hand or Right Hand; Designed for use below the floor;
Fitting does not have a baffle)

Part No.	Size	UPC# 611942-	A	B	C	D	E	F	Weight
EZS 51D***	4	04424	10 ³ / ₄	6 ¹ / ₂	3	4	9 ¹ / ₂	4 ¹ / ₂	15.0
EZS 51L	4	04425	10 ³ / ₄	6 ¹ / ₂	3	4	9 ¹ / ₂	4 ¹ / ₂	12.8
EZS 51R	4	04473	10 ³ / ₄	6 ¹ / ₂	3	4	9 ¹ / ₂	4 ¹ / ₂	12.6

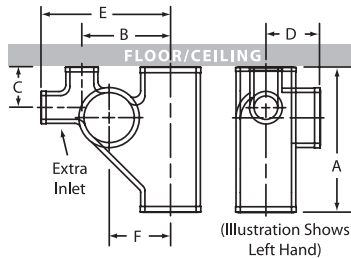

HOW TO DETERMINE RIGHT or LEFT HAND CROSS-OVER

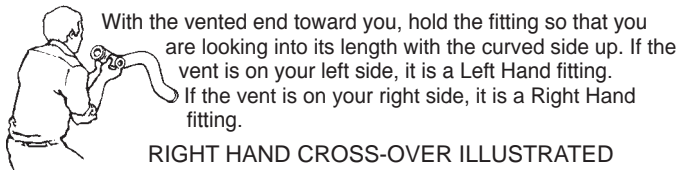

Note: VENT CROSS-OVER
for use with EZS-50 through 800 Series fittings.
Specify Right, Left, Plain or Double.

Note: Our crossovers are designed for use with EZS starter fittings, that is for the vent and stack centerline to be 6¹/₂"

PART NO. EZS 7

2" Vent Cross-Over, Plain
(No Outlets)

U.P.C. No.	Size	A	C	F	Weight
611942	2 x 18 ³ / ₈	4 ⁷ / ₈	9 ⁹ / ₁₆	18 ³ / ₈	8.1

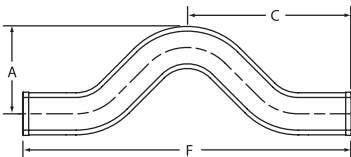

PART NO. EZS 7D

2" Vent Cross-Over, Double (2 Inlets)

U.P.C. No.	Size	A	B	C	F	Weight
611942	2 x 18 ³ / ₈	4 ⁷ / ₈	6 ¹ / ₂	9 ⁹ / ₁₆	18 ³ / ₈	8.0

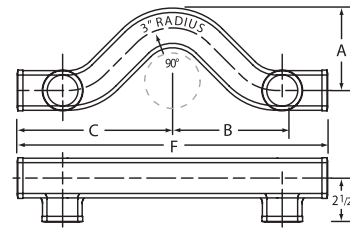

PART NO. EZS 7L

2" Vent Cross-Over with Left Hand Inlet

U.P.C. No.	Size	A	B	C	F	Weight
611942	2 x 18 ³ / ₈	4 ⁷ / ₈	6 ¹ / ₂	9 ⁹ / ₁₆	18 ³ / ₈	8.2

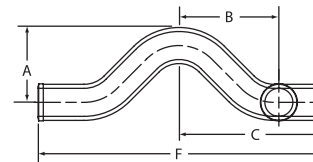

PART NO. EZS 7R

2" Vent Cross-Over with Right Hand Inlet

U.P.C. No.	Size	A	B	C	F	Weight
611942	2 x 18 ³ / ₈	4 ⁷ / ₈	6 ¹ / ₂	9 ⁹ / ₁₆	18 ³ / ₈	8.4

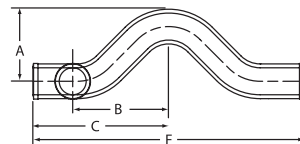

PART NO. EZS 1

Figure One

Size	E	F	D	Weight
2 x 1 ¹ / ₂	3 ³ / ₁₆	7	4 ⁷ / ₈	5.3

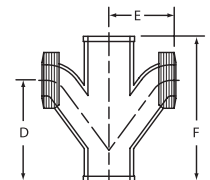

* When ordering please specify Double, Left or Right.
*** Double closet fitting does not have a baffle.

PART NO. NH 25

Figure Five Double Fixture Fitting

Size	D	E	F	G	Weight
2	6 1/2	5	8	1 13/16	7.0
3	8 7/8	6 9/16	10 1/8	2	10.5
3 x 2 x 3 x 3	8 7/8	6 9/16	9 1/4	2	10.7
4	10 1/4	7 3/4	12	1 15/16	22.5
4 x 2 x 4 x 4	10 1/4	7 3/4	11 1/2	1 15/16	19.8

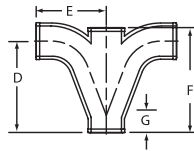

PART NO. EZS 8A

Figure Eight Double Fixture Fitting, Extended
(Designed for Use Below the Floor)**

Size	D	E	F	H	Weight
4 x 2	9	6 1/2	13	8	23.4

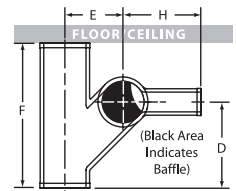

PART NO. EZS 6*

Figure Six

(Double, Left Hand or Right Hand; Designed for use below the floor)

Part No.	Size	C	D	E	F	H	Weight
EZS 6D**	3x2	4 1/8	7 9/16	5 1/16	11	3 7/16	13.0
EZS 6D**	4x2	4 1/2	9	6 1/2	13	4	23.1
EZS 6L	3x2	4 1/8	7 9/16	5 1/16	11	3 7/16	11.4
EZS 6L	4x2	4 1/2	9	6 1/2	13	4	18.0
EZS 6R	3x2	4 1/8	7 9/16	5 1/16	11	3 7/16	11.4
EZS 6R	4x2	4 1/2	9	6 1/2	13	4	18.0

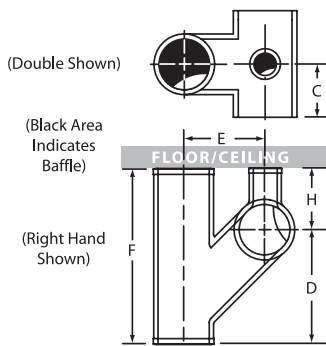

PART NO. EZS 100*

16" Closet Fittings with 2" Inlets

(Double, Left Hand or Right Hand; Designed for use below the floor)

Part No.	Size	A	B	C	D	E	M	Weight
EZS 100D	4x16	16 3/4	5	4 1/2	6 1/2	5 1/2	5	22.0
EZS 100L	4x16	16 3/4	5	4 1/2	6 1/2	5 1/2	5	20.0
EZS 100R	4x16	16 3/4	5	4 1/2	6 1/2	5 1/2	5	21.1

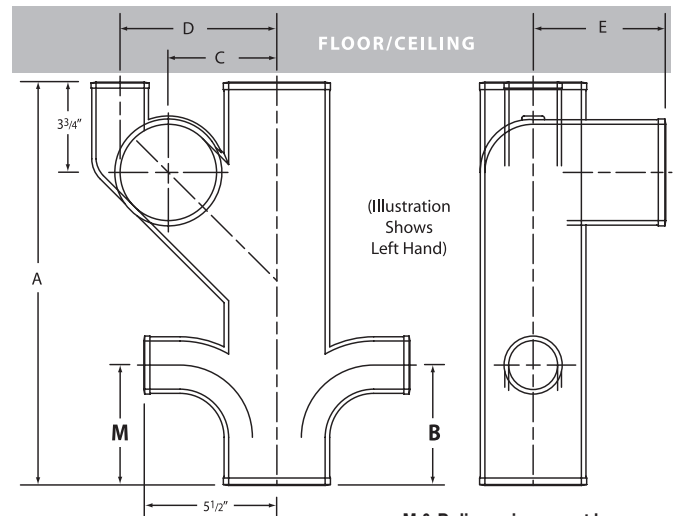

M & B dimensions must be measured from the bottom of the fitting.

PART NO. EZS 8*

Figure Eight

(Double, Left Hand or Right Hand; Designed for use below the floor)

Part No.	Size	C	D	E	F	H	Weight
EZS 8D**	3x2	4 1/8	7 9/16	5 1/16	11	3 7/16	13.0
EZS 8L	3x2	4 1/8	7 9/16	5 1/16	11	3 7/16	12.5
EZS 8L	4x2	4 1/2	9	6 1/2	13	4	19.8
EZS 8R	3x2	4 1/8	7 9/16	5 1/16	11	3 7/16	12.5
EZS 8R	4x2	4 1/2	9	6 1/2	13	4	19.8

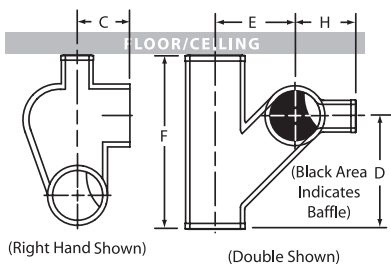

* When ordering please specify Double, Left or Right.

** Double fitting has a baffle.

PART NO. EZS 400*

30" Closet Fittings with 2" Inlet

(Double, Left Hand or Right Hand; Designed for use in the floor)

Part No.	Size	A	B	C	D	E	M	Weight
EZS 400L	4x30	30	0	4 1/2	6 1/2	5 1/2	0	34.0
EZS 400L	4x30	30	6 1/2	4 1/2	6 1/2	5 1/2	0	34.2
EZS 400L	4x30	30	12	4 1/2	6 1/2	5 1/2	0	37.8
EZS 400L	4x30	30	26 1/2	4 1/2	6 1/2	5 1/2	0	34.3
EZS 400L	4x30	30	0	4 1/2	6 1/2	5 1/2	4	34.0
EZS 400L	4x30	30	26 1/2	4 1/2	6 1/2	5 1/2	4	34.0
EZS 400L	4x30	30	0	4 1/2	6 1/2	5 1/2	6 1/2	33.1
EZS 400L	4x30	30	6 1/2	4 1/2	6 1/2	5 1/2	6 1/2	34.0
EZS 400L	4x30	30	26 1/2	4 1/2	6 1/2	5 1/2	6 1/2	36.8
EZS 400L	4x30	30	0	4 1/2	6 1/2	5 1/2	12	31.0
EZS 400L	4x30	30	26 1/2	4 1/2	6 1/2	5 1/2	12	30.0
EZS 400R	4x30	30	0	4 1/2	6 1/2	5 1/2	0	32.9
EZS 400R	4x30	30	6 1/2	4 1/2	6 1/2	5 1/2	0	34.5
EZS 400R	4x30	30	12	4 1/2	6 1/2	5 1/2	0	37.1
EZS 400R	4x30	30	26 1/2	4 1/2	6 1/2	5 1/2	0	33.8
EZS 400R	4x30	30	0	4 1/2	6 1/2	5 1/2	4	34.0
EZS 400R	4x30	30	26 1/2	4 1/2	6 1/2	5 1/2	4	28.9
EZS 400R	4x30	30	0	4 1/2	6 1/2	5 1/2	6 1/2	33.9
EZS 400R	4x30	30	6 1/2	4 1/2	6 1/2	5 1/2	6 1/2	35.4
EZS 400R	4x30	30	26 1/2	4 1/2	6 1/2	5 1/2	6 1/2	35.4
EZS 400R	4x30	30	0	4 1/2	6 1/2	5 1/2	12	31.0
EZS 400R	4x30	30	26 1/2	4 1/2	6 1/2	5 1/2	12	28.5
EZS 400D	4x30	30	0	4 1/2	6 1/2	5 1/2	0	29.3
EZS 400D	4x30	30	6 1/2	4 1/2	6 1/2	5 1/2	0	36.4
EZS 400D	4x30	30	12	4 1/2	6 1/2	5 1/2	0	39.6
EZS 400D	4x30	30	0	4 1/2	6 1/2	5 1/2	4	38.0
EZS 400D	4x30	30	0	4 1/2	6 1/2	5 1/2	6 1/2	35.6
EZS 400D	4x30	30	26 1/2	4 1/2	6 1/2	5 1/2	6 1/2	38.9
EZS 400D	4x30	30	0	4 1/2	6 1/2	5 1/2	12	35.7
EZS 400D	4x30	30	26 1/2	4 1/2	6 1/2	5 1/2	12	38.0

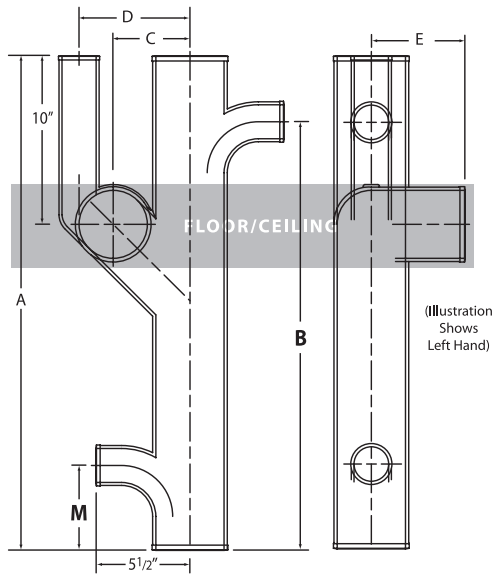

PART NO. EZS 700*

Threaded Starter Fitting with or without No-Hub Inlets

(Double, Left Hand or Right Hand; Designed for use above the floor with back-outlet water closets; Double Starter fittings have a baffle)

Part No.	Size	A	B	C	D	E	Weight
EZS 700D**	4x28	0	0	5 1/2	28	6 1/2	40.0
EZS 700D**	4x28	0	8 1/2	5 1/2	28	6 1/2	42.0
EZS 700D**	4x28	23 1/2	8 1/2	5 1/2	28	6 1/2	42.0
EZS 700L	4x28	0	0	5 1/2	28	6 1/2	34.6
EZS 700L	4x28	0	8 1/2	5 1/2	28	6 1/2	35.7
EZS 700L	4x28	14	8 1/2	5 1/2	28	6 1/2	36.3
EZS 700L	4x28	23 1/2	8 1/2	5 1/2	28	6 1/2	32.0
EZS 700R	4x28	0	0	5 1/2	28	6 1/2	30.0
EZS 700R	4x28	0	8 1/2	5 1/2	28	6 1/2	34.0
EZS 700R	4x28	14	8 1/2	5 1/2	28	6 1/2	35.3
EZS 700R	4x28	23 1/2	8 1/2	5 1/2	28	6 1/2	32.0

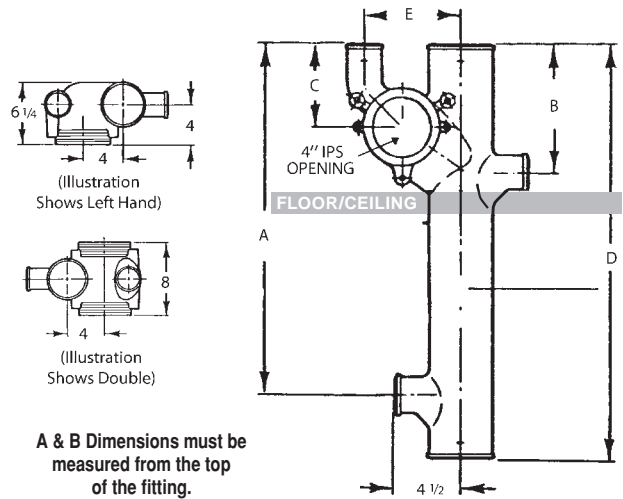

2" inlets available

Note: Trim package **not** included in price of fitting
"O" dimension denotes the absence of the designated inlet.

* When ordering please specify Double, Left or Right.
** Double starter fittings have a baffle.

PART NO. EZS 800*

Threaded Starter Fitting with or without No-Hub Inlets
 (Double, Left Hand or Right Hand; Designed for use above the floor with back-outlet water closets; Double starter fittings have a baffle)

Part No.	Size	A	B	C	D	E	Weight
EZS 800D**	4x28	16	0	5 1/2	28	6 1/2	42.0
EZS 800D**	4x28	16	8 1/2	5 1/2	28	6 1/2	42.0
EZS 800L	4x28	16	0	5 1/2	28	6 1/2	35.4
EZS 800L	4x28	16	8 1/2	5 1/2	28	6 1/2	36.3
EZS 800R	4x28	16	0	5 1/2	28	6 1/2	35.6
EZS 800R	4x28	16	8 1/2	5 1/2	28	6 1/2	35.3

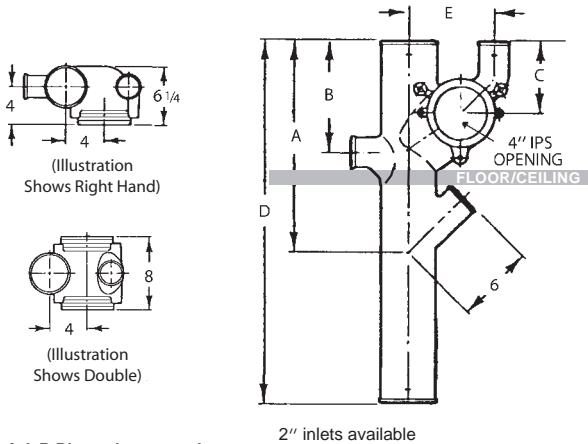

A & B Dimensions must be measured from the top of the fitting.

Note: Trim package **not** included in price of fitting
 "O" dimension denotes the absence of the designated inlet.

PART NO. EZS 710*

No-Hub Starter Fitting with or without 2" No-Hub Inlets
 (Double, Left Hand or Right Hand; Designed for use above the floor with back-outlet water closets; Double starter fittings have a baffle)

Part No.	Size	A	B	C	D	E	Weight
EZS 710D**	4x28	0	0	5 1/2	28	4	43.0
EZS 710D**	4x28	0	8 1/2	5 1/2	28	4	43.0
EZS 710D**	4x28	23 1/2	8 1/2	5 1/2	28	4	43.0
EZS 710L	4x28	0	0	5 1/2	28	4	36.6
EZS 710L	4x28	0	8 1/2	5 1/2	28	4	36.6
EZS 710L	4x28	14	8 1/2	5 1/2	28	4	36.6
EZS 710L	4x28	23 1/2	8 1/2	5 1/2	28	4	36.6
EZS 710R	4x28	0	0	5 1/2	28	4	36.6
EZS 710R	4x28	0	8 1/2	5 1/2	28	4	36.6
EZS 710R	4x28	14	8 1/2	5 1/2	28	4	36.6
EZS 710R	4x28	23 1/2	8 1/2	5 1/2	28	4	36.6

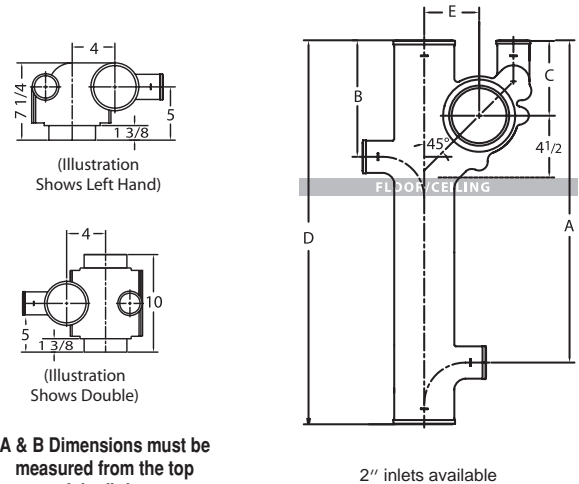

A & B Dimensions must be measured from the top of the fitting.

Note: Not designed for use with trim package
 "O" dimension denotes the absence of the designated inlet.

* When ordering please specify Double, Left or Right.
 ** Double starter fittings have a baffle.

PART NO. EZS 810*

No-Hub Starter Fitting with or without 2" No-Hub Inlets
(Double, Left Hand or Right Hand; Designed for use above the floor with back-outlet water closets; Double starter fittings have a baffle)

Part No.	Size	A	B	C	D	E	Weight
EZS 810D**	4x28	16	0	5½	28	6½	43.0
EZS 810D**	4x28	16	8½	5½	28	6½	43.0
EZS 810L	4x28	16	0	5½	28	6½	36.6
EZS 810L	4x28	16	8½	5½	28	6½	36.6
EZS 810R	4x28	16	0	5½	28	6½	36.6
EZS 810R	4x28	16	8½	5½	28	6½	36.6

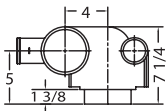

(Illustration Shows Right Hand)

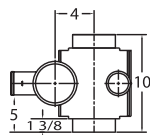

(Illustration Shows Double)

A & B Dimensions must be measured from the top of the fitting.

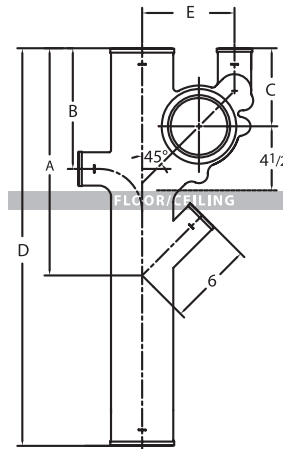

2" inlets available

Note: Not designed for use with trim package
"O" dimension denotes the absence of the designated inlet.

* When ordering please specify Double, Left or Right.
** Double starter fittings have a baffle.

MOUNTING HARDWARE

PART NO. EZS 22
Trim Package, Support Frame Assembly

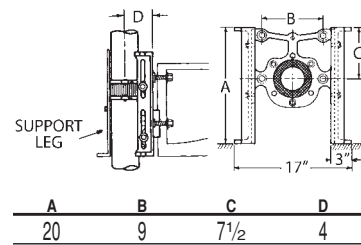

- 1—FRAME
- 1—LEFT LEG
- 1—RIGHT LEG
- 1—SUPPORT LEG (used for single only)
- 5—½" x ¼" BOLTS
- 5—½" FLAT WASHERS

PART NO. EZS 23
Trim Package, Floor-Mounted Back-Outlet Assembly
(Note: Not to be used with PART NO. EZS 22 Support Frame Assembly)

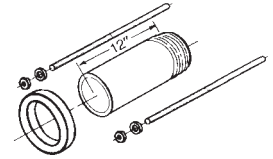

- 1—4" PVC Sch. 80 NIPPLE with TEST CAP
- 1—BOWL GASKET
- 2—5/16" x 12" RODS
- 2—5/16" HEX NUTS
- 2—5/16" FLAT WASHERS
- 2—5/16" CAP NUTS

PART NO. EZS 24
Trim Package, Wall-Hung Back-Outlet Assembly
(Note: To be used with PART NO. EZS 22 Support Frame Assembly)

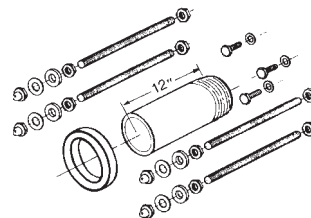

- 1—4" PVC Sch. 80 NIPPLE with TEST CAP
- 1—BOWL GASKET
- 4—5/8" x 12" RODS
- 4—5/8" CHROME CAP NUTS
- 8—5/8" JAM NUTS
- 4—5/8" FLAT WASHERS
- 4—5/8" FIBER WASHERS
- 3—3/8" x 1½" BOLTS FOR FACEPLATE
- 3—3/8" FLAT WASHERS
- 4—5/8" STAR WASHERS

Exploded View of Support Assembly Hardware

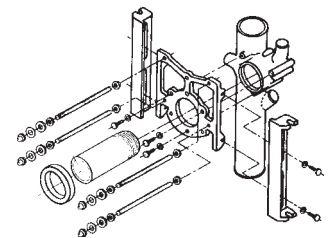

EZS 22 and EZS 24 Assemblies Illustrated

Plugs

PART NO. PLG 410

Ohio Code Brass Plug

Size	D	H	Weight
10	10 ²³ / ₃₂	2 ¹ / ₃₂	10.6

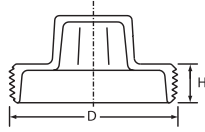

PART NO. PLG 430

Southern Code Brass Plug

Size	D	H	Weight
1 1/2	1 ⁵⁷ / ₆₄	4 ⁹ / ₆₄	0.2
2	2 ²³ / ₆₄	4 ⁹ / ₆₄	0.3
2 1/2	2 ⁵⁵ / ₆₄	5 ¹ / ₆₄	0.4
3	3 ¹⁵ / ₃₂	5 ⁷ / ₆₄	0.6
3 1/2	3 ⁶³ / ₆₄	5 ⁷ / ₆₄	0.7
4	4 ³¹ / ₆₄	6 ¹ / ₆₄	1.1
5	5 ³⁵ / ₆₄	6 ¹ / ₆₄	1.5
6	6 ¹⁹ / ₃₂	1 ⁷ / ₃₂	2.5
8	8 ³⁹ / ₆₄	1 ⁹ / ₃₂	4.0

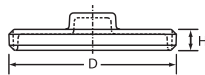

PART NO. PLG 440

Southern Code Countersunk Brass Plug

Size	D	H	Weight
1 1/2	1 ⁵⁷ / ₆₄	1 ³ / ₃₂	0.2
2	2 ²³ / ₆₄	7 ¹ / ₁₆	0.3
3	3 ¹⁵ / ₃₂	3 ³ / ₆₄	0.6
3 1/2	3 ⁶³ / ₆₄	3 ³ / ₆₄	0.8
4	4 ³¹ / ₆₄	3 ⁵ / ₆₄	0.9
5	5 ³⁵ / ₆₄	1 ¹ / ₁₆	1.7
6	6 ¹⁹ / ₃₂	1 ¹ / ₁₆	2.3

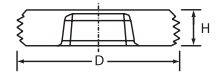

PART NO. PLG 450

Cast Iron Plug

Size	D	H	Weight
6	6 ³⁵ / ₆₄	1 ⁷ / ₆₄	4.2
10	10 ³⁹ / ₆₄	1 ³¹ / ₃₂	9.0

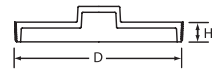

SUBMITTAL FOR CHARLOTTE® STANDARD NO-HUB COUPLINGS

Date: _____

Job Name: _____

Location: _____

Engineer: _____

Contractor: _____

▶ **Charlotte® Standard No-Hub Couplings**, manufactured by Ideal Clamp Products, are engineered to connect hub-less cast iron pipe and fittings. The coupling sleeve or gasket is manufactured from a properly vulcanized virgin compound where the primary elastomer is polychloroprene (neoprene). The gasket is housed inside a 301 stainless steel corrugated shield. Depending on the size of the shield, (2) or (4) 301 stainless steel clamps surround the shield and provide the sealing force. The 5/16" hex-head screws are made from 305 grade stainless steel. The Charlotte Standard No-Hub Couplings are available in sizes ranging from 1½" – 10". The couplings are designed for installation torque of 60 in-lbs. The entire coupling is corrosion resistant.

Size	Installation Torque Inch Pounds	No. of Clamps Per Coupling
1½"	60	2
2"	60	2
3"	60	2
4"	60	2
5"	60	4
6"	60	4
8"	60	4
10"	60	4
2" x 1½"	60	2
3" x 2"	60	2
4" x 3"	60	2

▶ **The Design:**

The Charlotte Standard No-Hub Coupling is engineered to provide superior sealing performance. The coupling is NSF® Certified* and is in full compliance to CISPI 310, ASTM C 1277 and ASTM C 564. ***Sizes 1½" through 10" only**

▶ **The Gasket:**

The gasket is made from a properly vulcanized virgin compound in compliance to ASTM C 564. The Charlotte No-Hub gasket features multiple sealing beads under the clamp bands. The sealing beads on the gasket impede the movement of the gasket and pipe, providing a positive, reliable seal.

▶ **The Shield:**

The 0.007" thick type 301 stainless steel shield requires less band load to transfer pressure to the gasket, leaving more clamping load in reserve to compress the gasket. The patented, bi-directional corrugations create clamp sealing pressure in both parallel and transverse patterns on the gasket and pipe, thereby avoiding pull-out failures, and providing a positive, reliable seal.

▶ **The Clamps:**

Standard 301 stainless steel clamps and 5/16" hex-head 305 screws provide the sealing force. 1½" through 4" couplings use two (2) clamps; 5" through 10" couplings use four (4) clamps. The entire assembly is corrosion resistant.



▶ **CHARLOTTE® STANDARD NO-HUB COUPLINGS**

Product Information Submittal for No-Hub Systems

TEST	GASKET PHYSICAL TEST MIN. OR MAX. REQUIREMENTS	ASTM METHOD
Tensile Strength	1500 psi min.	D 412
Elongation	250 min.	D 412
Durometer (Shore A)	70 +/-5 @ 76°F +/- 5°F	D 2240
Accelerated Aging	15% maximum tensile and 20% maximum elongation, 10 points maximum increase in hardness, all determinations after oven aging for 96 hours at 158°F	D 573
Compression Set	25% max. after 22 hours at 158°F	D 395 Method B
Oil Immersion	80% max. volume change after immersion in IRM 903 for 70 hours at 212°F.	D 471
Ozone Cracking	No visible cracking at 2 times magnification of the gasket after 100 hours exposure in 1.5 ppm ozone concentration at 104°F. Testing and inspection to be on gasket which is loop mounted to give approximately 20% elongation of outer surface.	D 1149
Tear Resistance	150 lbf /in. min.	D 624
Water Absorption	20% max. by weight after 7 days at 158°F	D 471

MATERIALS	
Clamp	Type 301 AISI stainless steel
Screw	Type 305 AISI stainless steel 5/16" hex head/shoulder
Shield	Type 301 AISI stainless steel, corrugated. Shield thickness 0.007"
Gasket	The gasket is made of an elastomeric compound that meets the requirements of ASTM C 564

- ▶ The Charlotte® patented Standard No-Hub Coupling has been engineered to provide an all stainless steel coupling, balancing the desire for a more rigid joint with the need to provide a superior, positive, reliable seal which can accommodate possible disparities in the mating of No-Hub pipe and fittings.

The 1½", 2", 3" and 4" diameter couplings consist of a 2½" wide bi-directional, corrugated 301 stainless steel shield in conjunction with two (2) stainless steel clamps mounted in a series, secured in place by means of fixed and "floating" eyelets to allow the clamp "travel" during tightening. The 5" and 6" couplings consist of a 3" wide corrugated 301 stainless steel shield in conjunction with four (4) clamps and the 8" and 10" coupling consists of a 4" wide corrugated 301 stainless steel shield with four (4) stainless steel clamps.

All Charlotte Standard No-Hub Couplings are designed to be installed with a pre-set torque wrench calibrated at 60 in-lbs. to accommodate the 305 stainless steel 5/16" hex-head/shoulder screw.



SUBMITTAL FOR CHARLOTTE® HEAVY-DUTY "MD" NO-HUB COUPLINGS

Date: _____

Job Name: _____

Location: _____

Engineer: _____

Contractor: _____

▶ **Charlotte® Heavy-Duty "MD" (yellow shield) No-Hub Couplings**, manufactured by Ideal Clamp Products, are engineered to connect No-Hub cast iron pipe in applications replacing the less-efficient hub & spigot material. Coupling consists of an elastomeric compound gasket (ASTM C 564) housed inside a 304 stainless steel corrugated shield. Depending on the size of the shield, (4) or (6) 304 stainless steel clamps surround the shield and provide the sealing force. The 5/16" hex-head screws are made from 305 stainless steel. The Charlotte patented Heavy-Duty "MD" No-Hub Couplings are available in sizes ranging from 1½" – 10". The couplings are designed to be torqued to 80 in-lbs. The entire coupling is corrosion resistant. Conforms to ASTM C 1540.

Heavy-Duty "MD" No-Hub Couplings		
Size	Installation Torque Inch Pounds	No. of Clamps Per Coupling
1½"	80	4
2"	80	4
3"	80	4
4"	80	4
5"	80	6
6"	80	6
8"	80	6
10"	80	6

▶ **The Design:**

The Charlotte Heavy-Duty "MD" No-Hub Couplings are engineered to provide all the extra holding power of a Heavy-Duty coupling without all the extra cost. Conforms to ASTM C 1540.

▶ **The Gasket:**

Made from high-quality elastomeric compound (ASTM C 564), the Charlotte No-Hub gasket features a pattern of multiple thick sealing sectors and adjacent groove sectors laterally spaced. When the clamps are tightened, this pattern permits the clamping bands and the shield to form a restriction impeding the movement of the shield relative to the gasket.

▶ **The Shield:**

0.008" thick type 304 stainless steel yellow shield requires less band load to transfer pressure to the gasket, leaving more clamping load in reserve to compress the gasket. The patented, bi-directional corrugations create clamp sealing pressure in both parallel and transverse patterns on the gasket and pipe, thereby avoiding pull-out failures, and providing a positive, reliable seal.

▶ **The Clamps:**

Heavy-duty 304 stainless steel clamps and 5/16" hex-head 305 screws provide the sealing force. 1½" through 4" couplings use four (4) clamps; 5" through 10" couplings use six (6) clamps. The entire assembly is corrosion resistant.



▶ **CHARLOTTE® HEAVY-DUTY "MD" NO-HUB COUPLINGS**

Product Information Submittal for No-Hub Systems

TEST	GASKET PHYSICAL TEST MIN. OR MAX. REQUIREMENTS	ASTM METHOD
Tensile Strength	1500 psi min.	D 412
Elongation	250 min.	D 412
Durometer (Shore A)	70 +/-5 @ 76°F +/- 5°F	D 2240
Accelerated Aging	15% maximum tensile and 20% maximum elongation, 10 points maximum increase in hardness, all determinations after oven aging for 96 hours at 158°F	D 573
Compression Set	25% max. after 22 hours at 158°F	D 395 Method B
Oil Immersion	80% max. volume change after immersion in IRM 903 for 70 hours at 212°F.	D 471
Ozone Cracking	No visible cracking at 2 times magnification of the gasket after 100 hours exposure in 1.5 ppm ozone concentration at 104°F. Testing and inspection to be on gasket which is loop mounted to give approximately 20% elongation of outer surface.	D 1149
Tear Resistance	150 lbf /in. min.	D 624
Water Absorption	20% max. by weight after 7 days at 158°F	D 471

MATERIALS	
Clamp	Type 304 AISI stainless steel
Screw	Type 305 AISI stainless steel 5/16" hex head/shoulder
Shield	Type 304 AISI stainless steel, corrugated. Shield thickness 0.008"
Gasket	The gasket is made of an elastomeric compound that meets the requirements of ASTM C 564

▶ The Charlotte® Heavy-Duty "MD" No-Hub Coupling has been engineered to provide a mid-range, all stainless steel coupling, balancing the desire for a more rigid joint with the need to provide a superior, positive seal which can accommodate possible disparities in the mating of No-Hub pipe and fittings. This has been accomplished by manufacturing our coupling with a mid-range corrugated shield of sufficient width to accommodate additional surface-bearing sealing clamps.

The additional sealing clamps, when torqued to 80 in-lbs, deliver additional performance benefits. First the overall dimensional thickness of the clamp and shield, in conjunction with the additional width of the coupling, result in a more uniformly rigid joint, with the load being supported at both the outer edge of the coupling and the centerline of the joint. Second, the additional sealing clamps yield increased surface-bearing contact between the coupling and the pipe or fittings, thereby inhibiting joint movement at higher internal pressures not commonly associated with DWV systems.

The 1½", 2", 3" and 4" diameter couplings consist of a 3" wide bi-directional, corrugated 304 stainless steel shield in conjunction with four (4) stainless steel clamps mounted in a series, secured in place by means of fixed and "floating" eyelets to allow the clamp "travel" during tightening. The 5", 6" 8" and 10" couplings consist of a 4" corrugated 304 stainless steel shield and six (6) stainless steel clamps.

All Charlotte Heavy-Duty "MD" No-Hub Couplings are designed to be installed with a pre-set torque wrench calibrated at 80 in-lbs. accommodates the 305 stainless steel 5/16" hex-head/shoulder screw.



SUBMITTAL FOR CHARLOTTE® HEAVY-DUTY "HD" NO-HUB COUPLINGS

Date: _____

Job Name: _____

Location: _____

Engineer: _____

Contractor: _____

▶ **Charlotte® Heavy-Duty "HD" (green shield) No-Hub Couplings**, manufactured by Ideal Clamp Products, are engineered to connect No-Hub cast iron pipe in applications replacing the less-efficient hub & spigot material. The Coupling consists of an elastomeric compound gasket (ASTM C 564) housed inside a 304 stainless steel corrugated shield. Depending on the size of the shield, (4) or (6) 304 stainless steel clamps surround the shield and provide the sealing force. The 3/8" hex-head screws are made from 305 stainless- steel. Charlotte Heavy-Duty "HD" No-Hub Couplings are available in sizes ranging from 1½" – 10". The couplings are designed to be torqued to 80 in-lbs. The entire coupling is corrosion resistant. Conforms to ASTM C 1540.

Heavy-Duty "HD" No-Hub Couplings		
Size	Installation Torque Inch Pounds	No. of Clamps Per Coupling
1½"	80	4
2"	80	4
3"	80	4
4"	80	4
5"	80	6
6"	80	6
8"	80	6
10"	80	6

▶ **The Design:**

Charlotte Heavy-Duty "HD" No-Hub Couplings have been re-engineered to install with 80 in-lbs. of screw torque and boasts an ultimate torque rating exceeding 100 in/lbs. Our patented, extra wide bi-directional shield is now constructed with a heavier gauge stainless steel. The mechanically interlocked 9/16" wide clamps have also been augmented with a heavier gauge stainless steel and a 3/8" hex-head screw. These changes, teamed with our specially beaded gasket, enable our new Heavy-Duty "HD" coupling to exert exceptional hold on the pipe for a positive, reliable seal. Conforms to ASTM C 1540.

▶ **The Gasket:**

Made from high-quality elastomeric compound (ASTM C 564), the Charlotte No-Hub gasket features a pattern of multiple thick sealing sectors and adjacent groove sectors laterally spaced. When the clamps are tightened, this pattern permits the clamping bands and the shield to form a restriction impeding the movement of the shield relative to the gasket.

▶ **The Shield:**

0.008" thick type 304 stainless steel green shield requires less band load to transfer pressure to the gasket, leaving more clamping load in reserve to compress the gasket. The patented, bi-directional corrugations create clamp sealing pressure in both parallel and transverse patterns on the gasket and pipe, thereby avoiding pull-out failures, and providing a positive, reliable seal.

▶ **The Clamps:**

Heavy-duty 304 stainless steel clamps and 3/8" hex-head 305 screws provide the sealing force. 1½" through 4" couplings use four (4) clamps; 5" through 10" couplings use six (6) clamps. The entire assembly is corrosion resistant.



▶ **CHARLOTTE® HEAVY-DUTY "HD" NO-HUB COUPLINGS**

Product Information Submittal for No-Hub Systems

TEST	GASKET PHYSICAL TEST MIN. OR MAX. REQUIREMENTS	ASTM METHOD
Tensile Strength	1500 psi min.	D 412
Elongation	250 min.	D 412
Durometer (Shore A)	70 +/-5 @ 76°F +/- 5°F	D 2240
Accelerated Aging	15% maximum tensile and 20% maximum elongation, 10 points maximum increase in hardness, all determinations after oven aging for 96 hours at 158°F	D 573
Compression Set	25% max. after 22 hours at 158°F	D 395 Method B
Oil Immersion	80% max. volume change after immersion in IRM 903 for 70 hours at 212°F.	D 471
Ozone Cracking	No visible cracking at 2 times magnification of the gasket after 100 hours exposure in 1.5 ppm ozone concentration at 104°F. Testing and inspection to be on gasket which is loop mounted to give approximately 20% elongation of outer surface.	D 1149
Tear Resistance	150 lbf /in. min.	D 624
Water Absorption	20% max. by weight after 7 days at 158°F	D 471

MATERIALS

Clamp	Type 304 AISI stainless steel
Screw	Type 305 AISI stainless steel 3/8" hex head/shoulder
Shield	Type 304 AISI stainless steel, corrugated. Shield thickness 0.008"
Gasket	The gasket is made of an elastomeric compound that meets the requirements of ASTM C 564

▶ The Charlotte® patented Heavy-Duty "HD" No-Hub Coupling has been engineered to provide a heavy-duty, all stainless steel coupling, balancing the desire for a more rigid joint with the need to provide a superior, positive seal which can accommodate possible disparities in the mating of No-Hub pipe and fittings. This has been accomplished by manufacturing our Charlotte patented No-Hub Heavy-Duty "HD" coupling with a heavy-duty corrugated shield of sufficient width to accommodate additional surface-bearing sealing clamps.

The additional sealing clamps, when torqued to 80 in-lbs., deliver additional performance benefits. First, the overall dimensional thickness of the clamp and shield, in conjunction with the additional width of the coupling, result in a more uniformly rigid joint, with the load being supported at both the outer edge of the coupling and the centerline of the joint. Second, the additional sealing clamps yield increased surface-bearing contact between the coupling and the pipe or fittings, thereby inhibiting joint movement at higher internal pressures not commonly associated with DWV systems.

The 1½", 2", 3" and 4" diameter couplings consist of a 3" wide bi-directional, corrugated 304 stainless steel shield in conjunction with four (4) stainless steel clamps mounted in a series, secured in place by means of fixed and "floating" eyelets to allow the clamp "travel" during tightening. The 5", 6" 8" and 10" couplings consist of a 4" corrugated 304 stainless steel shield and six (6) stainless steel clamps.

All Charlotte patented Heavy-Duty "HD" No-Hub Couplings are designed to be installed with a pre-set torque wrench calibrated at 80 in-lbs. to accommodate the 305 stainless steel 3/8" hex-head/shoulder screw.



SUBMITTAL FOR CHARLOTTE® 12" AND 15" HEAVY-DUTY NO-HUB COUPLINGS

Date: _____

Job Name: _____

Location: _____

Engineer: _____

Contractor: _____

▶ **Charlotte® Heavy-Duty No-Hub Couplings**, manufactured by Ideal Clamp Products, are engineered to connect No-Hub cast iron pipe in applications replacing the less-efficient hub & spigot material. The Couplings consist of an elastomeric compound gasket (ASTM C 564) housed inside a 304 stainless steel corrugated shield. Six (6) 304 stainless steel clamps surround the shield and provide the sealing force. The 3/8" hex-head screws are made from 305 stainless steel. The Couplings are designed for installation torque of 120 in-lbs. The entire coupling is corrosion resistant.

12" & 15" Heavy-Duty No-Hub Couplings		
Size	Installation Torque Inch Pounds	No. of Clamps Per Coupling
12"	120	6
15"	120	6

▶ **The Design:**

Charlotte 12" and 15" Heavy-Duty No-Hub Couplings are engineered to provide superior performance at a very competitive cost. Conforms to ASTM C 1277.

▶ **The Gasket:**

Made from high-quality elastomeric compound (ASTM C 564), the Charlotte No-Hub gasket features a pattern of multiple, thick sealing sectors and adjacent groove sectors laterally spaced. When the clamps are tightened, this pattern permits the clamping bands and the shield to form a restriction impeding the movement of the shield relative to the gasket.

▶ **The Shield:**

0.008" thick type 304 stainless steel shield requires less band load to transfer pressure to the gasket, leaving more clamping load in reserve to compress the gasket. The patented, bi-directional corrugations create clamp sealing pressure in both parallel and transverse patterns on the gasket and pipe, thereby avoiding pull-out failures, and providing a positive, reliable seal. In addition, the shield design adjusts to differences in the circumference and outside diameters of the pipes being joined. This eliminates gasket wrinkling and thereby eliminating leak paths.

▶ **The Clamps:**

Heavy-duty 304 stainless steel clamps and 3/8" hex-head 305 screws provide the sealing force. Both the 12" and the 15" coupling use six (6) 5/8" wide clamps. The entire assembly is corrosion resistant.



▶ **CHARLOTTE® 12" & 15" NO-HUB COUPLINGS**

Product Information Submittal for No-Hub Systems

TEST	GASKET PHYSICAL TEST MIN. OR MAX. REQUIREMENTS	ASTM METHOD
Tensile Strength	1500 psi min.	D 412
Elongation	250 min.	D 412
Durometer (Shore A)	70 +/-5 @ 76°F +/- 5°F	D 2240
Accelerated Aging	15% maximum tensile and 20% maximum elongation, 10 points maximum increase in hardness, all determinations after oven aging for 96 hours at 158°F	D 573
Compression Set	25% max. after 22 hours at 158°F	D 395 Method B
Oil Immersion	80% max. volume change after immersion in IRM 903 for 70 hours at 212°F.	D 471
Ozone Cracking	No visible cracking at 2 times magnification of the gasket after 100 hours exposure in 1.5 ppm ozone concentration at 104°F. Testing and inspection to be on gasket which is loop mounted to give approximately 20% elongation of outer surface.	D 1149
Tear Resistance	150 lbf /in. min.	D 624
Water Absorption	20% max. by weight after 7 days at 158°F	D 471

MATERIALS	
Clamp	Type 304 AISI stainless steel
Screw	Type 305 AISI stainless steel 3/8" hex head/shoulder
Shield	Type 304 AISI stainless steel, corrugated. Shield thickness 0.008"
Gasket	The gasket is made of an elastomeric compound that meets the requirements of ASTM C 564

- ▶ The Charlotte® Heavy-Duty No-Hub Coupling has been engineered to provide an all stainless steel coupling, balancing the desire for a more rigid joint with the need to provide a superior, positive, reliable seal which can accommodate possible disparities in the mating of No-Hub pipe and fittings. This has been accomplished by manufacturing our coupling with our standard corrugated shield of sufficient width to accommodate additional surface-bearing sealing clamps.

The additional sealing clamps, when torqued to 120 in-lbs., deliver additional performance benefits. First, the overall dimensional thickness of the clamp and shield, in conjunction with the additional width of the coupling, result in a more uniformly rigid joint, with the load being supported at both the outer edge of the coupling and the centerline of the joint. Second, the additional sealing clamps yield increased surface-bearing contact between the coupling and the pipe or fittings, thereby inhibiting joint movement at higher internal pressures not commonly associated with DWV systems.

The 12" and 15" diameter couplings consist of a 5 1/2" wide bi-directional, corrugated 304 stainless steel shield in conjunction with six (6) stainless steel clamps mounted in a series, secured in place by means of fixed and "floating" eyelets to allow the clamp "travel" during tightening.



LIMITED WARRANTY

Charlotte Pipe and Foundry Company® (Charlotte Pipe®) Products are warranted to be free from manufacturing defects and to conform to currently applicable ASTM standards for a period of five (5) years from date of delivery. Buyer's remedy for breach of this warranty is limited to replacement of, or credit for, the defective product. This warranty excludes any expense for removal or reinstallation of any defective product and any other incidental, consequential, or punitive damages. **This limited warranty is the only warranty made by seller and is expressly in lieu of all other warranties, express and implied, including any warranties of merchantability and fitness for a particular purpose.** No statement, conduct or description by Charlotte Pipe or its representative, in addition to or beyond this Limited Warranty, shall constitute a warranty. This Limited Warranty may only be modified in writing signed by an officer of Charlotte Pipe.

This Limited Warranty will not apply if:

- 1) The Products are used for purposes other than their intended purpose as defined by local plumbing and building codes, and the applicable ASTM standard.
- 2) The Products are not installed in good and workmanlike manner consistent with normal industry standards; installed in compliance with the latest instructions published by Charlotte Pipe and good plumbing practices; and installed in conformance with all applicable plumbing, fire and building code requirements.
- 3) This limited warranty does not apply when the products of Charlotte Pipe are used with the products of other manufacturers that do not meet the applicable ASTM or CISPI standards or that are not marked in a manner to indicate the entity that manufactured them.
- 4) In hubless cast iron installations, this warranty will not apply if products are joined with unshielded hubless couplings. Charlotte Pipe requires that its hubless cast iron pipe and fittings be joined only with shielded hubless couplings manufactured in accordance with CISPI 310, ASTM C 1277 and certified by NSF® International or with Heavy Duty Couplings meeting ASTM C 1540.
- 5) The Products fail due to defects or deficiencies in design, engineering, or installation of the piping system of which they are a part.
- 6) The Products have been the subject of modification; misuse; misapplication; improper maintenance or repair; damage caused by the fault or negligence of anyone other than Charlotte Pipe; or any other act or event beyond the control of Charlotte Pipe.
- 7) The Products fail due to the freezing of water in the Products.
- 8) The Products fail due to contact with chemical agents, fire stopping materials, thread sealant, plasticized vinyl products, or other aggressive chemical agents that are not compatible.
- 9) Pipe outlets, sound attenuation systems or other devices are permanently attached to the surface of Charlotte® PVC, ABS or CPVC products with solvent cement or adhesive glue.

Charlotte Pipe products are manufactured to the applicable ASTM or CISPI standard. Charlotte Pipe and Foundry **cannot** accept responsibility for the performance, dimensional accuracy, or compatibility of pipe, fittings, gaskets, or couplings not manufactured or sold by Charlotte Pipe and Foundry.

This Limited Warranty will not apply unless written notice of a claim is mailed to Charlotte Pipe at the address below within 30 days of discovery of the allegedly defective product.

Any Charlotte Pipe products alleged to be defective **must** be made available to Charlotte Pipe at the following address for verification, inspection and determination of cause:

Charlotte Pipe and Foundry Company
Attention: Technical Services
2109 Randolph Road
Charlotte, North Carolina 28207

Purchaser must obtain a return materials authorization and instructions for return shipment to Charlotte Pipe of any product claimed defective or shipped in error.

Any Charlotte Pipe product **proved** to be defective in manufacture will be replaced F.O.B. point of original delivery, or credit will be issued, at the discretion of Charlotte Pipe.

4/20/21

Charlotte, Charlotte Pipe and "You can't beat the system" are registered trademarks of Charlotte Pipe and Foundry Company.

PO BOX 35430 CHARLOTTE, NORTH CAROLINA 28235
SALES PHONE (704) 348 6450 (800) 572 4199
TECHNICAL PHONE (800) 438 6091 FAX (800) 553 1605
WWW.CHARLOTTEPIPE.COM

CHARLOTTE

PIPE AND FOUNDRY COMPANY®

PO BOX 35430

CHARLOTTE

NORTH CAROLINA 28235

PHONE (704) 348-6450

(800) 438-6091

FAX (800) 553-1605

WWW.CHARLOTTEPIPE.COM



All products manufactured by
Charlotte Pipe and Foundry Company
are proudly made in the U.S.A.